





ASSEMBLY INSTRUCTIONS

MODEL : B3100-11 MIRROR

DOC. NO : RD-F05-AT
REV. NO : A
REV. DATE : 25.08.2006

REV. : A DATE : 28.01.2016

Component List		
NO.	Descriptions	Qty.
A	MIRROR (Packed inside Mirror)	1
B	MIRROR SUPPORT RAIL (Packed inside Mirror)	2
C	DRESSER (Packed Separately)	1

Hardware List		
NO.	Descriptions	Qty.
1	Screw-M6x40MM Jcbc Screw Blk 	8
2	Washer - Spring Washer M6 	8
3	Washer - Flat Washer 1/4" (BLK) 	8
4	M4 L Key 	1

STEP 1.1

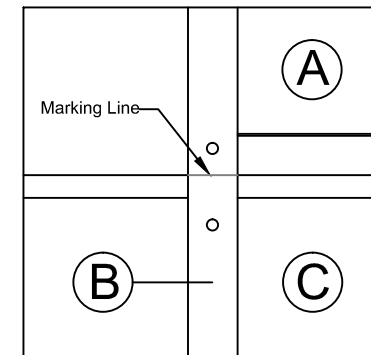

STEP 1.2

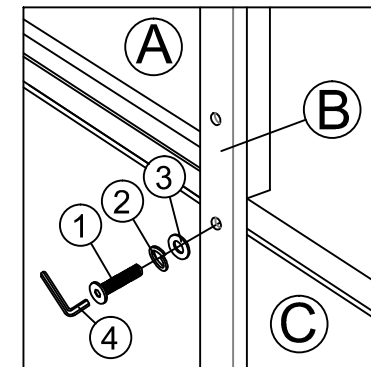

REMARK : UPPER BACK RAIL
SUPPORT HAVE SHAPE

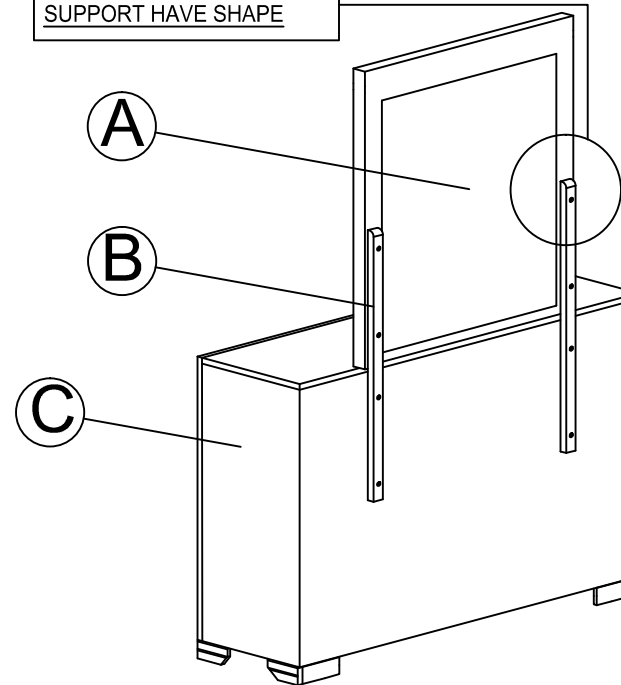

STEP 1.1

Align the marking line with Dresser Top.

STEP 1.2

Attach the Back Support Rail (B) to the back of Mirror (A) and Dresser (C). Secured the Back Support Rail (B) by using Flat washer (3), Spring washer (2) and JCBC bolt (1) using Allen key provided.

ASSEMBLY TIPS:

- 1.Remove hardware from box and sort by size.
- 2.Please check to see that all hardware and parts are present prior start of assembly.
- 3.Please follow attached instructions in the same sequence as numbered to assure fast and easy assembly.

Warning!

- 1.Don't attempt to repair or modify parts that are broken or defective.Please contact the store immediately.
- 2.This product is for home use only and not intended for commercial establishments.