









# ASSEMBLY INSTRUCTIONS

ITEM NO : B3100-1-N  
DRESSER

### BOX OF DRESSER

ITEM	DRAWING	DESCRIPTION	QTY
A		DRESSER	1
B		LEG (Packed underneath bottom panel)	4
C		SUPPORT LEG (Packed underneath bottom panel)	1
D		TIPPING RESTRAINT (Affix to wall behind dresser) * Located in the Right Side Front Drawer	1

### BOX OF DRESSER HARDWARE LIST

ITEM	DRAWING	DESCRIPTION	QTY
1		JCBC SCREW (M6 x 50mm)	8
2		SPRING WASHER (M6)	8
3		FLAT WASHER (1/4)	8
4		ALLEN KEY (M4)	1

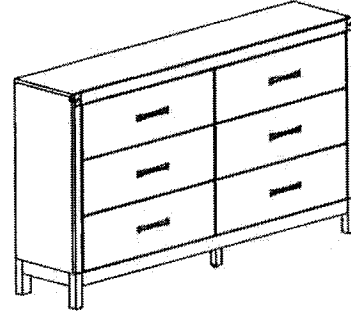

COMPLETED DRESSER ASSEMBLY

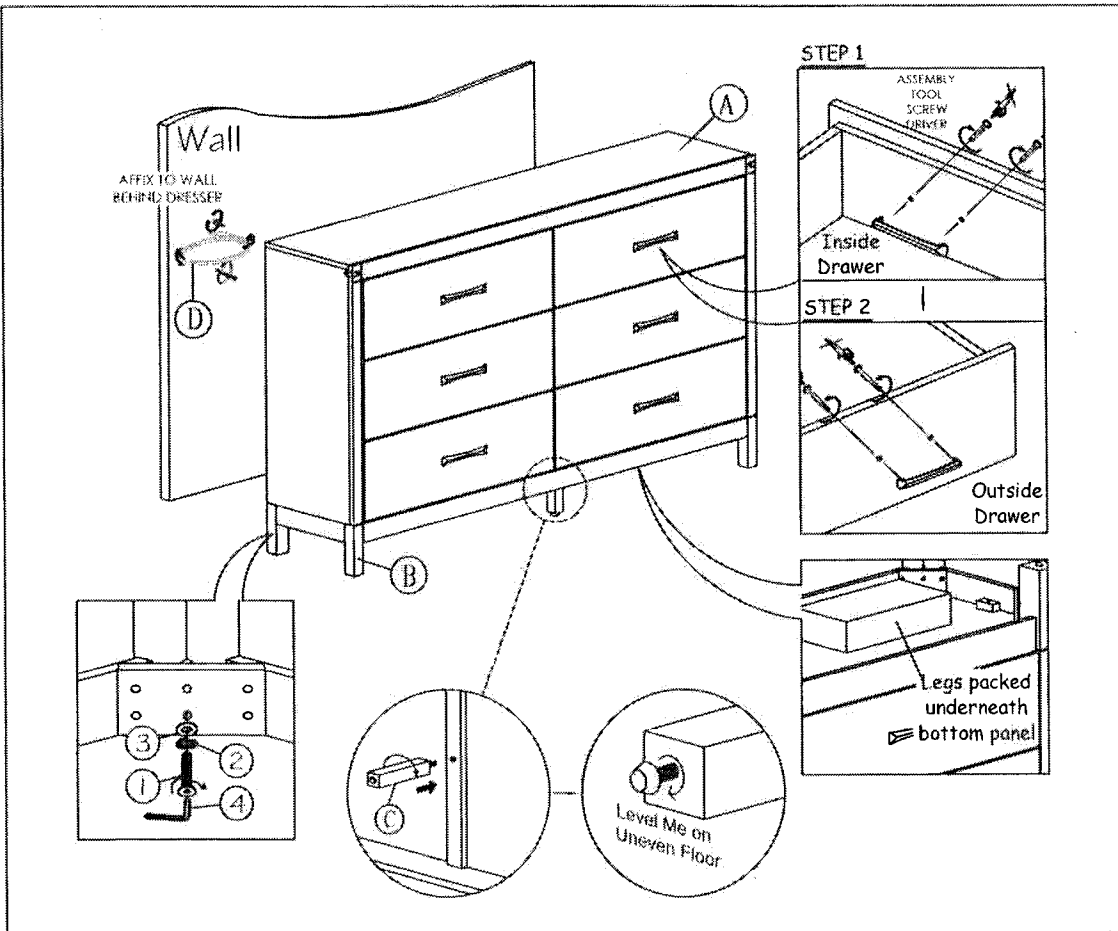

THE HARDWARE IS LOCATED IN THE PACKING ITEMS  
THE ANTI TIPPING HARDWARE IS LOCATED IN THE RIGHT SIDE FRONT DRAWER OF DRESSER

NOTE : MUST TIGHTEN SCREWS PERIODICALLY WITH USE SCREWS MAY BECOME LOOSE.  
CHECK TIGHTNESS OF ALL SCREWS EVERY 6-8 WEEKS.

#### CLEANING INSTRUCTION

After assembled, clean & polish the completed parts if necessary with soft cloth and industrial recognized furniture polish

MADE IN MALAYSIA