

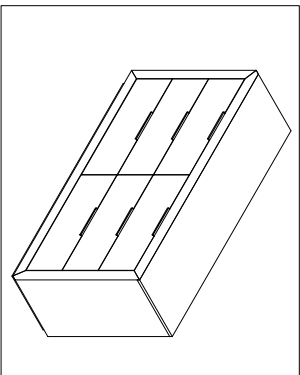

## LIVING SPACES

A	7602		x 2
---	------	-------------------------------------------------------------------------------------	-----



#22460  
Pierce Bedroom  
6-Drawer Dresser



1

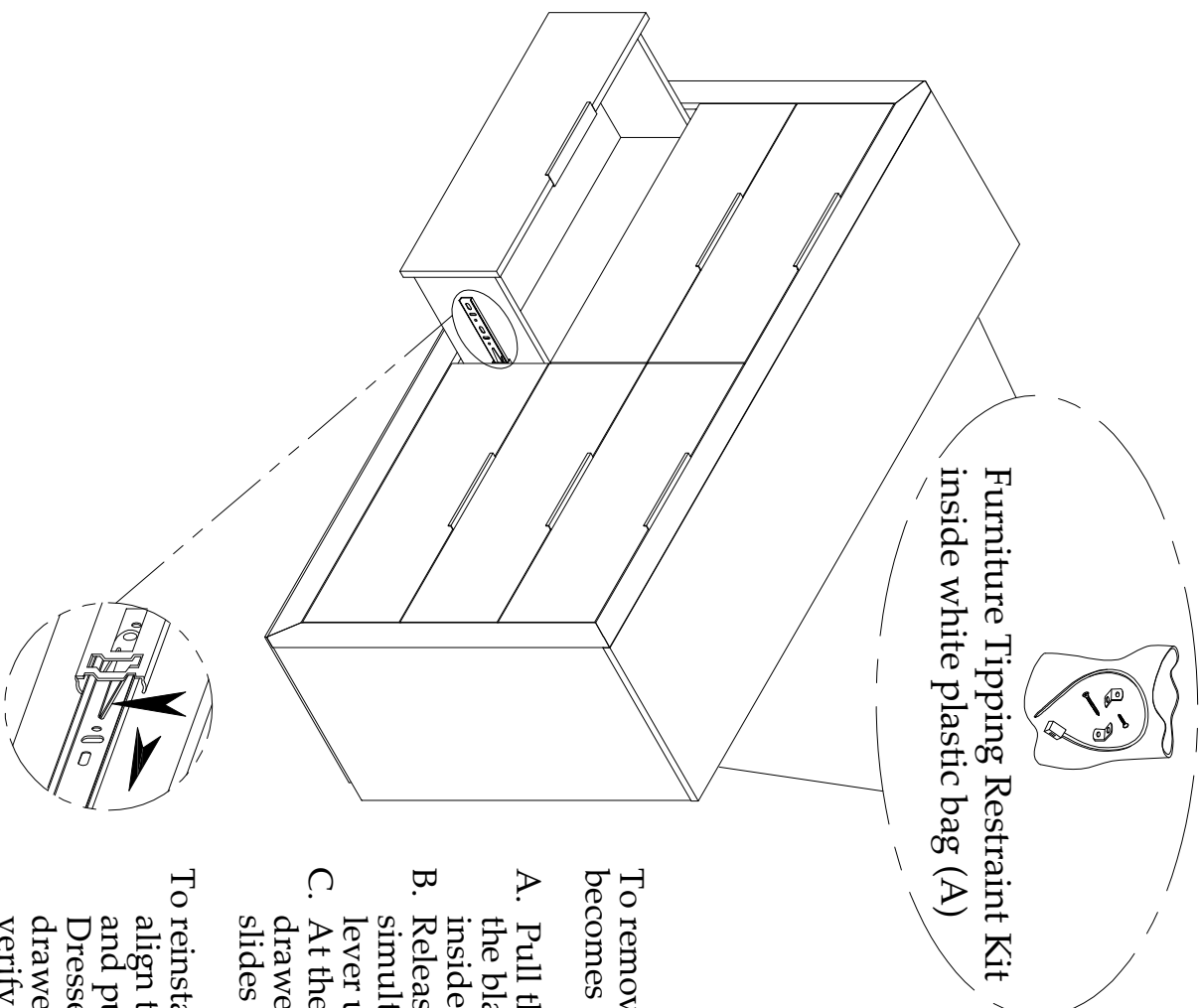







To remove the drawer if it ever becomes necessary:

- Pull the drawer fully open so the black latch is visible in the inside channel of the guides.
- Release the latches by simultaneously pushing one lever up and the other down.
- At the same time, pulling the drawer forward until the slides release.

To reinstall the drawers, carefully align the channels of the guide and push drawer back into Dresser. Open and close drawer fully a couple times to verify proper operation.

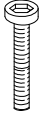

# LIVING SPACES

<b>A</b>	5204		x 2
<b>B</b>	7002 Parts C - F		x 1
<b>C</b>	1/4-20 x 1-5/8" Long Allen Head Bolt		x 8
<b>D</b>	M 1/4" Spring Washer		x 8
<b>E</b>	M1/4" x 19 x 2mm Flat Washer		x 8
<b>F</b>	4mm Allen Wrench		x 1

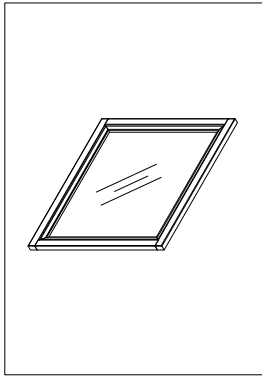

#222461  
Pierce Bedroom  
Mirror

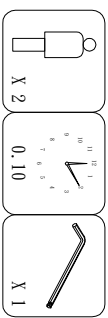

1

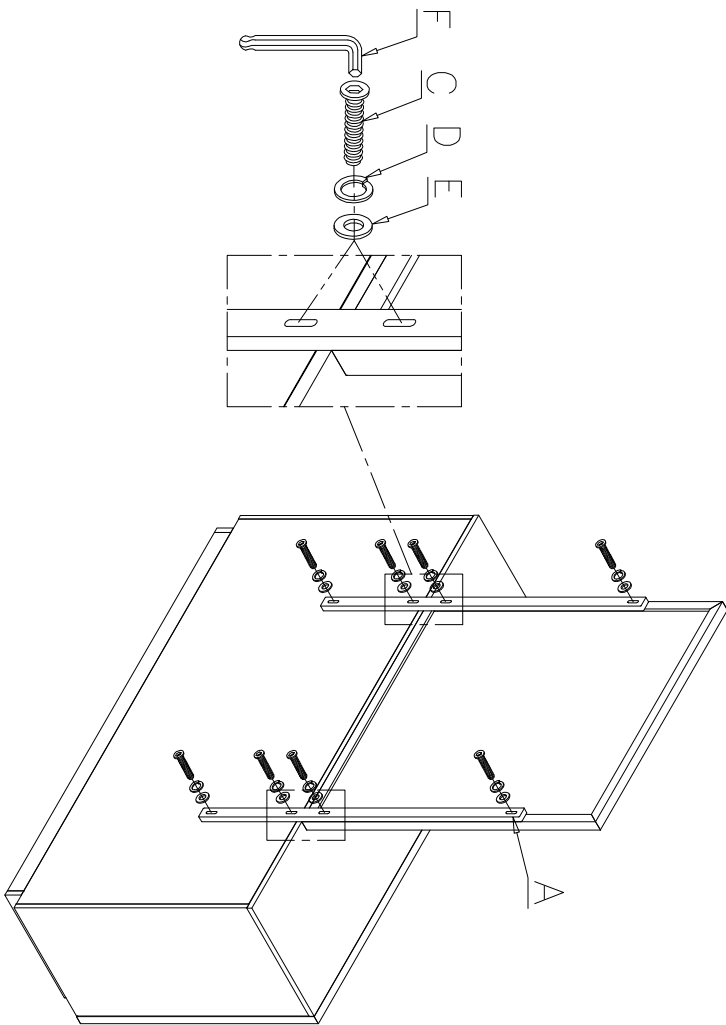

2

