

Martinique II Swivel Counter Stool
17BC318A

Assembly Instruction

Parts List:







REF.	PART NAME	PART IMAGE	Q'TY	REF.	PART NAME	PART IMAGE	Q'TY
A	Seat		1	D	Lock Washer(1/4")		4
B	Base		1	E	Bolt(1/4"×25MM)		4
C	Washer(1/4")		4	F	Allen Wrench		1

Diagram:



Assembly Step:

Step1:Pls remove protective wrapping and lay all parts on the floor.Make sure all parts packed in carton against attached parts list are presented.

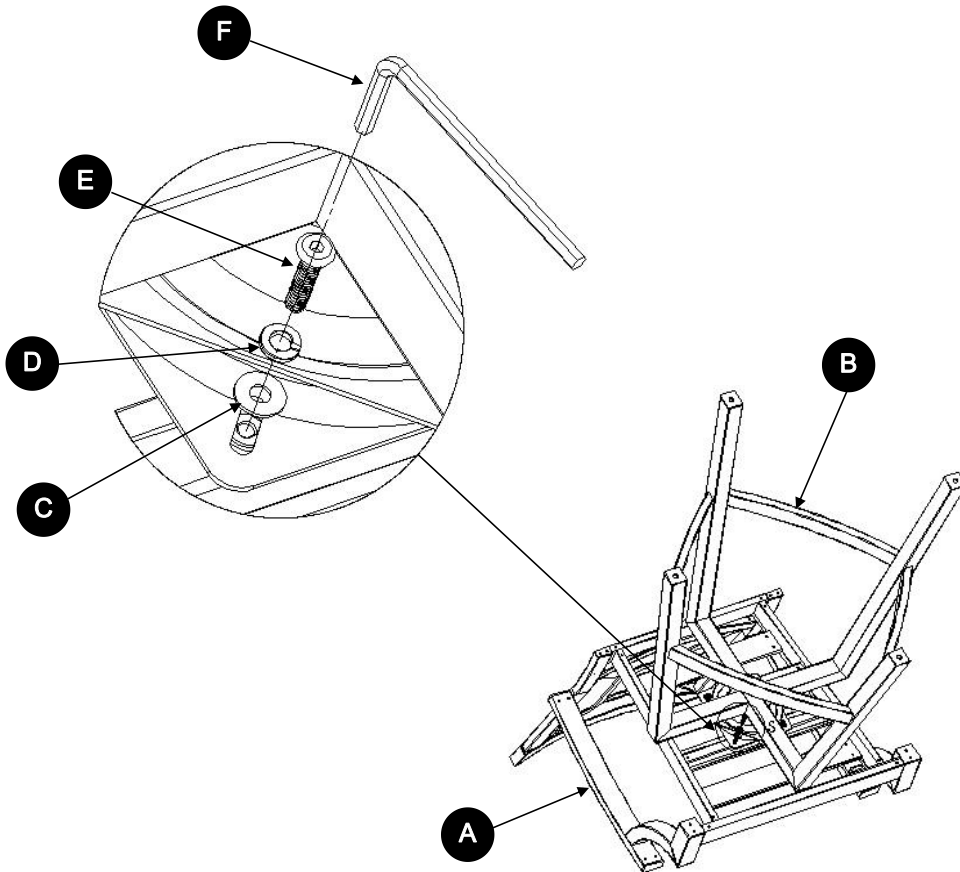
Step2:Place a protective soft material before laying the seat on floor,assemble the base as the above diagram.

Step3:After all parts are aligned and tightened properly,pls turn over the counter stool carefully with a second person's assistance.Make sure the legs are on a flat surface.