



LIVING SPACES



Assembly Instructions For

BDAVEHBSF MADISON WHITE FL HEADBOARD SPINDLE
BDAVEHBFP MADISON PINK FL HEADBOARD SPINDLE

Thank you for purchasing this quality product. Be sure to check all packing materials carefully for small parts, which may have come loose inside the carton during shipment. Identify and count all parts and compare with the **HARDWARE LIST** below.

Caution : Please read instructions thoroughly before unpacking assembly parts.

1. We recommend that you should assemble this product with the assistance of another person; this will make assembly easier, and will help to eliminate damage to the product or injury to persons during assembly.
2. Please do not over tighten screws or bolts until the assembly is completed.
3. Please put all parts on a non - abrasive floor before assembly, and follow the assembly steps to assemble your newly purchased product correctly and efficiently.

NO.	PARTS LIST		Q'TY
A		Headboard	1
B		Bun Feet	2

Step 1

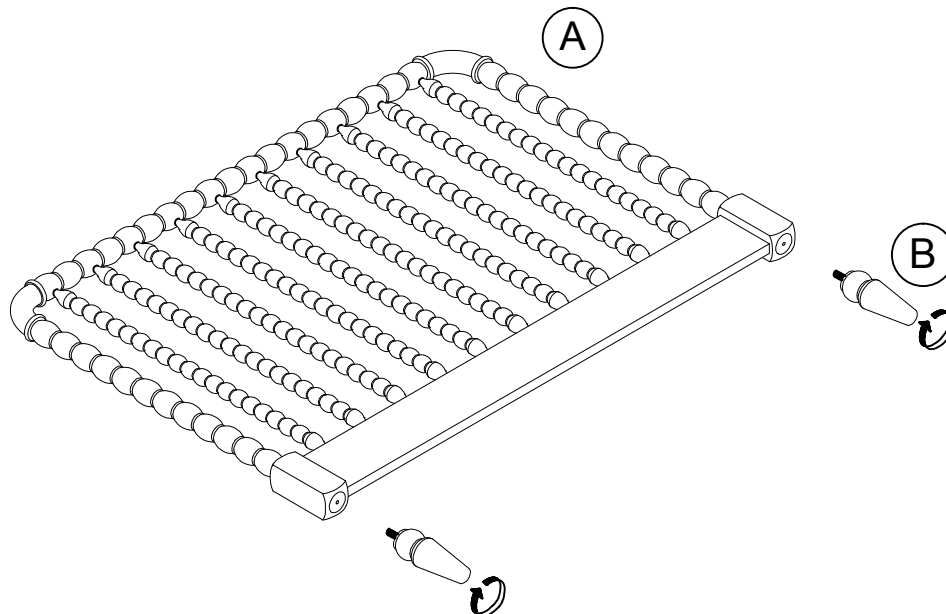

Made in VietNam



LIVING SPACES





Assembly Instructions For

BDAVEFBSF MADISON WHITE FL FOOTBOARD SPINDLE
BDAVEFBSFP MADISON PINK FL FOOTBOARD SPINDLE

Thank you for purchasing this quality product. Be sure to check all packing materials carefully for small parts, which may have come loose inside the carton during shipment. Identify and count all parts and compare with the **HARDWARE LIST** below.

Caution : Please read instructions thoroughly before unpacking assembly parts.

1. We recommend that you should assemble this product with the assistance of another person; this will make assembly easier, and will help to eliminate damage to the product or injury to persons during assembly.
2. Please do not over tighten screws or bolts until the assembly is completed.
3. Please put all parts on a non - abrasive floor before assembly, and follow the assembly steps to assemble your newly purchased product correctly and efficiently.

NO.	PARTS LIST		Q'TY
C		Footboard	1
B		Bun Feet	2
D		Slat Roll	1 Set
E		Support Legs	3

TOOLS REQUIRED (NOT PROVIDED)
PHILLIPS SCREWDRIVER 

Step 2

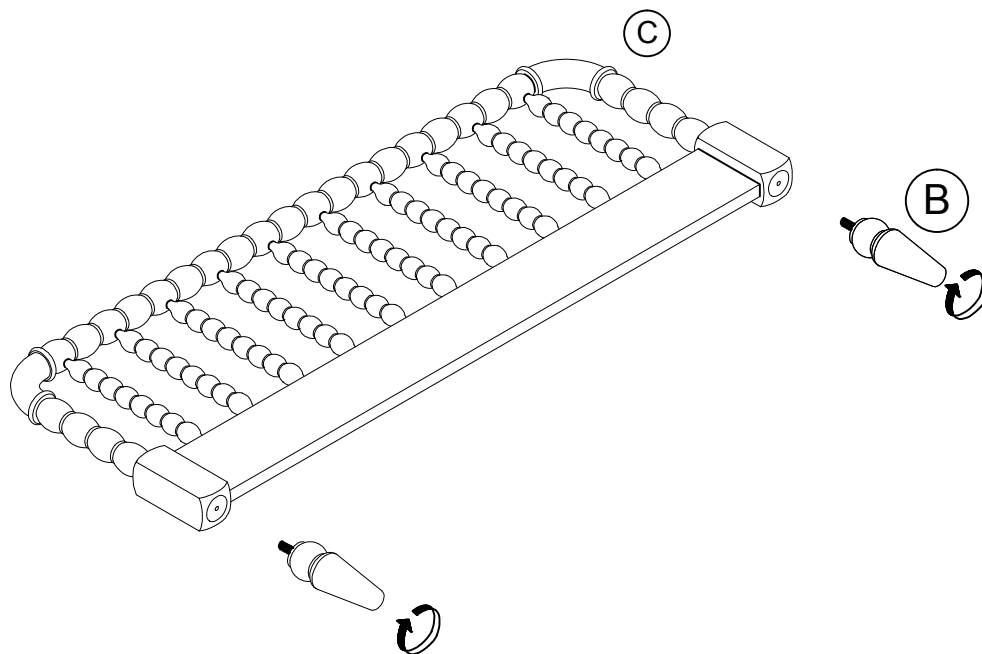







LIVING SPACES

Assembly Instructions For

BDAVEHBSF MADISON WHITE FL HEADBOARD SPINDLE
 BDAVEFBSF MADISON WHITE FL FOOTBOARD SPINDLE
 BDAVERSFTS MADISON WHITE TW/FL RAILS SPINDLE BED
 BDAVEHBFP MADISON PINK FL HEADBOARD SPINDLE
 BDAVEFBSFP MADISON PINK FL FOOTBOARD SPINDLE
 BDAVERSFTSP MADISON PINK TW/FL RAILS SPINDLE BED

NO.	PARTS LIST		Q'TY
F		Rails	2

NO.	HARDWARE LIST		Q'TY
1		Ø5/16" x 25 Flat washer Ø9" x Ø22 x 1.5	8
		Spring washer Ø9" x Ø13 x 1.5	
		Allen wrench 4mm	
2		Slat Screw Ø4 x 25	6
3		Wood Dowel Ø8 x 30	8

Step 3

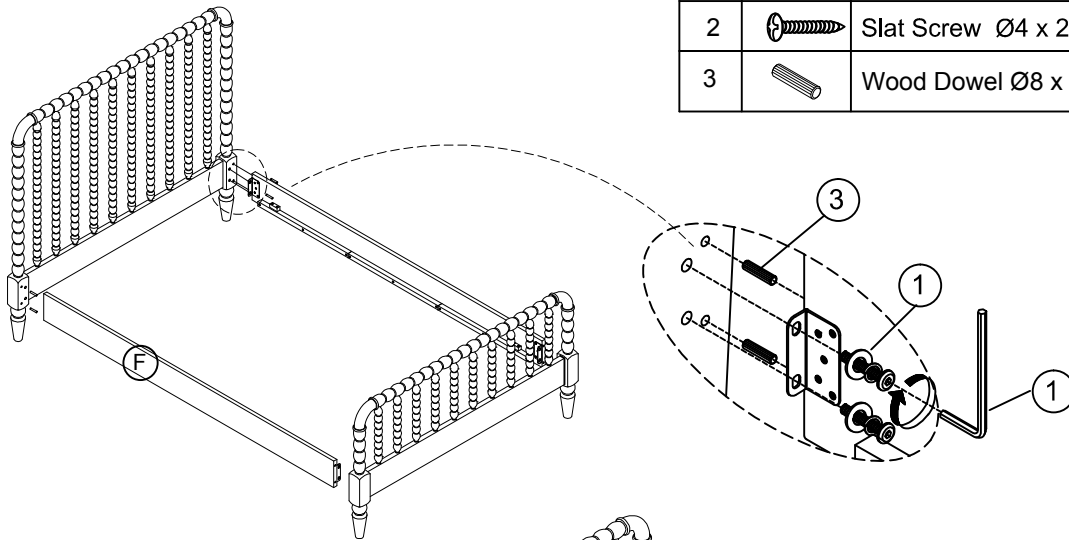

Step 4

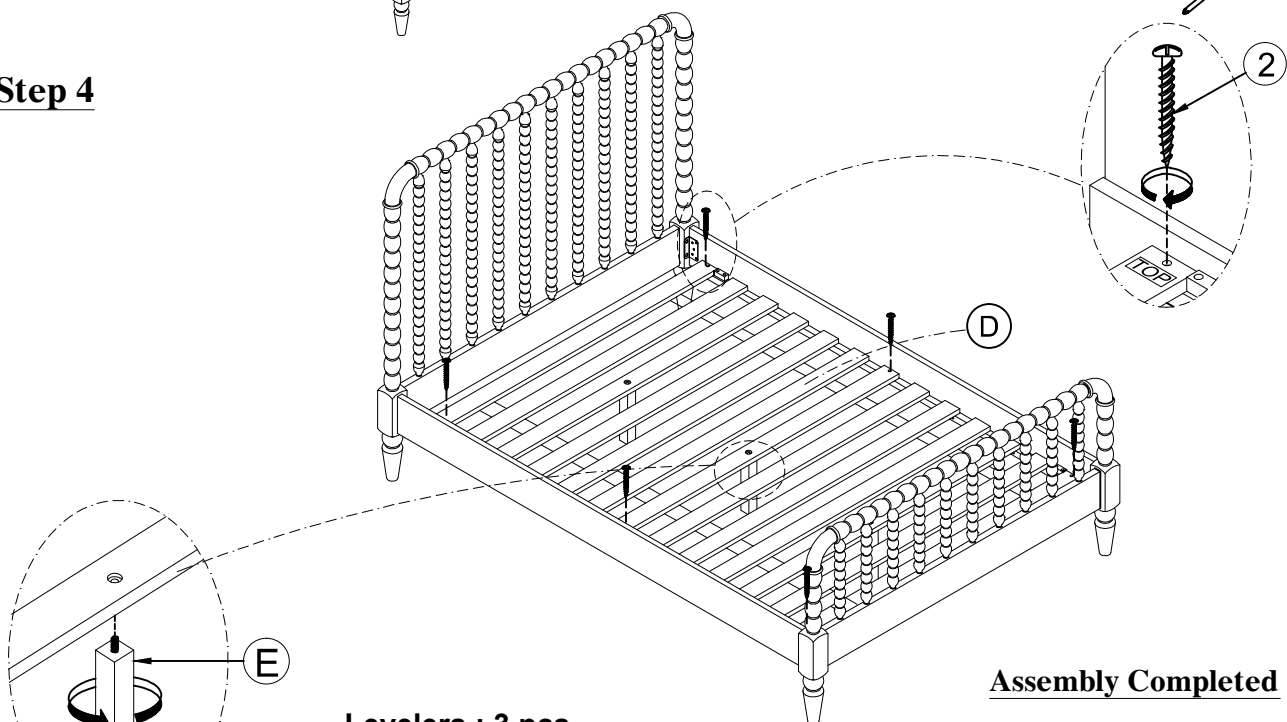

Levelers : 3 pcs
Adjust Levelers until
it is balanced and
touching the floor

Assembly Completed

Made in VietNam