

Assembly Instructions For



ALTON DRESSER & MIRROR

Thank you for purchasing this quality product. Be sure to check all packing materials carefully for small parts, which may have come loose inside the carton during shipment. Identify and count all parts and compare with the **HARDWARE LIST** below.

Caution: Please read instructions thoroughly before unpacking assembly parts.

1. We recommend that you assemble this product with the assistance of another person; this will make assembly easier, and will help to eliminate damage to the product or injury to persons during assembly.
2. Please do not over tighten screws or bolts until the assembly is completed.
3. Please put all parts on a non-abrasive floor before assembly, and follow the assembly steps to assemble your newly purchased product correctly and efficiently.

NO.	Hardware List		Q' TY
1		Ø5/16" * 18*1-3/8"L Allen Bolt	8
		Ø5/16" * Ø13mm Spring washer	8
		Ø5/16" * Ø19mm * 1.5mm Flat washer	8
		Allen wrench (4mm)	1
2		Furniture tipping restraint	1

NO.	Parts list		Q' TY
A		Dresser	1
B		Mirror	1
C		Support Slats	2

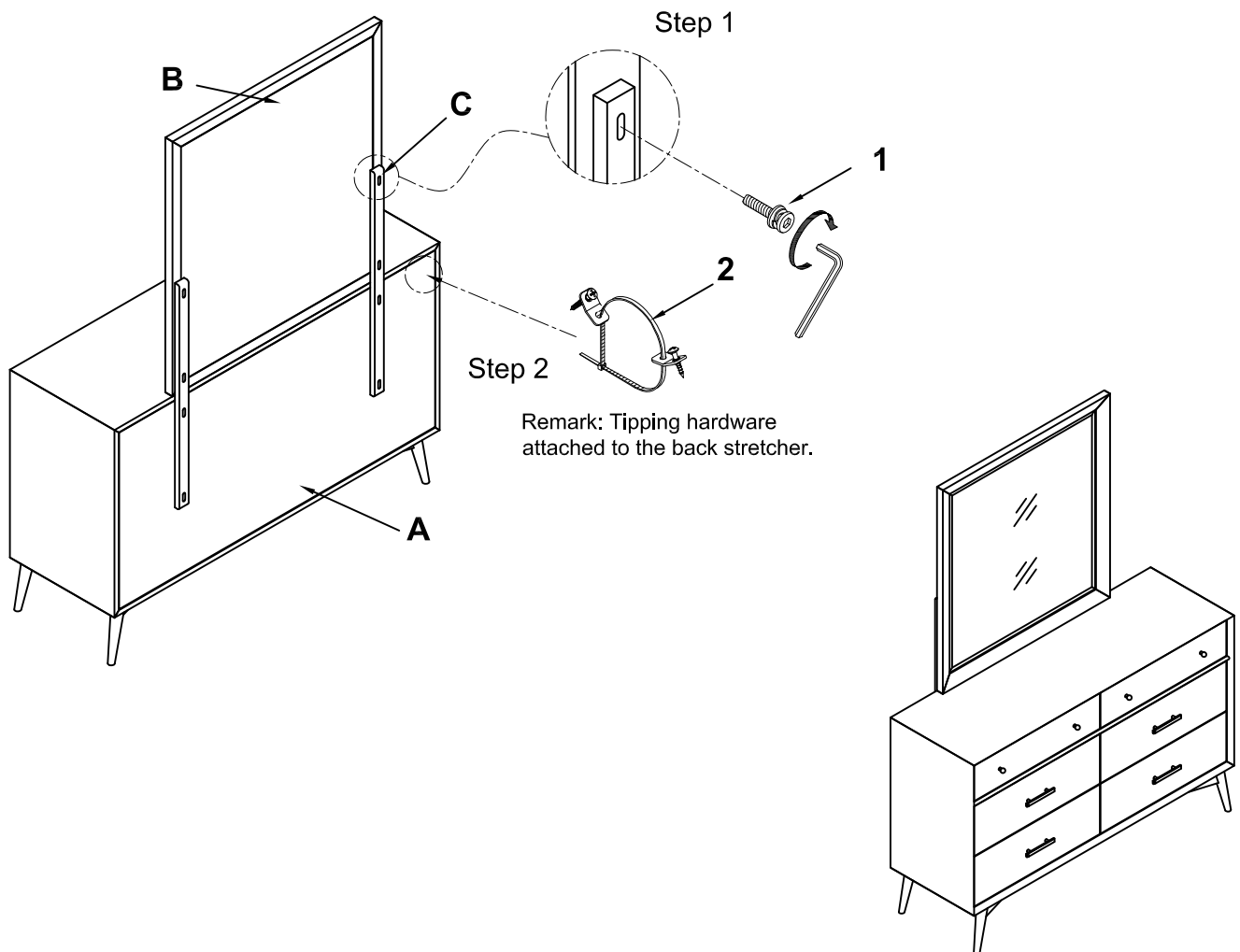

Assembly completed
Made in Vietnam

VERY IMPORTANT!!

CARING INSTRUCTIONS

NEVER

USE GLASS CLEANERS ON FINISHED FURNITURE. AMMONIA WILL CHEMICALLY ATTACK THE LACQUER.

NEVER

ALLOW LIQUIDS OF ANY KIND TO REMAIN IN DECORATIVE ROUTE LINES. ABSORPTION CAUSES WOOD TO WARP AND FINISHES TO DE-LAMINATE

DO NOT WRITE DIRECTLY ON SURFACE

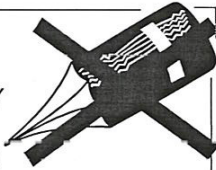

PREVENT MARKING

DO NOT PLACE IN DIRECT SUNLIGHT

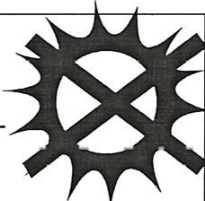

PREVENT FADING

DO NOT USE RUBBER-BASED PLACEMATS USE CLOTHS!



PREVENT DISCOLORING

DO NOT USE COMMERCIAL WAXES AND POLISHES



PREVENT YELLOWING

DO NOT PLACE HOT KETTLES POTS, ETC ON SURFACE



PREVENT DAMAGE TO FINISH

MAINTAIN EVEN HUMIDITY CONDITIONS IN YOUR HOME

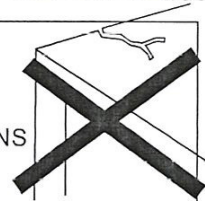

PREVENT SPLITTING

TO CLEAN

SIMPLY USE A SOFT CLOTH MOISTENED IN LEMON OIL POLOSH OR LUKEWARM SOAP & WATER THEN BUFF WITH A DRY CLEAN CLOTH!

