

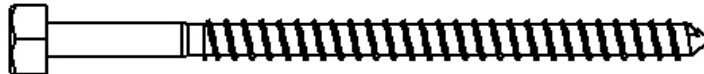

MAS90: 5043-43416	
<u>4144 HARDWARE LIST:</u>	
<u>QTY:</u>	<u>DESCRIPTION:</u>
32	1/4 X 4 HEX LAG BLK
32	3/16 USS FL WASHER BLK
20	6 X 1 1/4 PHIL FLAT PARTICLE BOARD SCREW
4	1/2 X 3 FLUTED DOWEL

 **LAG BOLT**
 **WASHER**
 **PHIL FLAT PARTICLE BOARD SCREW**
 **FLUTED DOWEL**

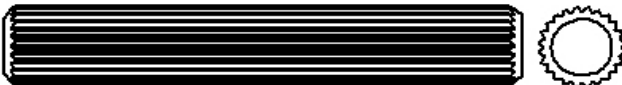

PARTS LIST:

- A) 32-4 1/4" Lag Bolts
- B) 32-Black Steel Washers
- C) 2 -Bottom End Assemblies
- D) 2 -Top End Assemblies
- E) 4 -5 1/4" x 75" Mattress Rails w/Support Cleats
- F) 4 -3 1/4" x 75" Guard Rails
- G) 4 -1/2" x 3" Wooden Dowels
- H) 6 -3 1/2" x 53 3/4" Mattress Supports
- I) 20-1 1/4" Wood Screws

TOOLS REQUIRED:

- 1) 7/16" Wrench or Socket Wrench
- 2) Phillips Head Screwdriver

Recommended: Electric driver with 7/16" socket

Make sure you have all parts before beginning assembly. If you need a part, contact Living Spaces.

- 1) Attach two mattress rails(E) to two bottom end assemblies(C) with 8 lag bolts and 8 washers, and tighten. Be sure that the holes in the legs of the bottom ends are pointed UP for this step!
- 2) Attach two mattress rails(E) and four guard rails(F) to top end assembly(D) with 24 lag bolts and 24 washers, and tighten. Be sure that the holes in the legs of the top ends are pointed DOWN for this step!
- 3) Roll out Full Slat Kit on mattress rail cleats, making sure to stretch it from end panel to end panel. Secure with 4 wood screws at the ends of the two outermost slats. One in each corner of the bed. Center 3 individual Full slats in the 3 gaps built into the Slat kit, and secure with wood screws, one in each end of the individual slats. Install one Slat Kit in each bed surface, top and bottom.
- 4) Place four wooden dowels in the four holes at the top of each bottom bed post (leg).
- 5) Lift the top bunk assembly up onto the bottom bunk assembly, ensuring that all 4 dowels are inserted into the holes in the bottom of the top bed posts (legs)
- 6) Add Mattresses no thicker than 10" and sleep well!
- 7) Slide Stairway Chest next to bed and attach with supplied L-brackets and screws.



00500

SAFETY WARNING

Our Bunk Beds have been tested by an Independent Laboratory and are certified to be in compliance with: ASTM F-1427, “Standard Consumer Safety Specification for Bunk Beds” and U.S. Government specifications 16 Code of Federal Regulations, parts 1213 and 1513.

SAFETY WARNINGS

1. Follow the information on the warnings attached to the upper bunk end structure and on the carton. Do not remove this label.
2. Always use the recommended size mattress or mattress support, or both, to help prevent the likelihood of entrapment or falls.
3. Surface of mattress must be at least five inches(127mm) below the upper edge of guardrails.
4. Do not allow children less than six years of age to use the upper bunk.
5. Periodically, check and ensure that the guardrail, ladder and other components are in their proper position, free from damage and that all connectors are tight.
6. Do not allow horseplay on or under the bed and prohibit jumping on the bed.
7. Prohibit more than one person on upper bunk.
8. Always use the ladder or bed end for entering and leaving the upper bunk.
9. Do not use substitute parts. Contact manufacturer or dealer for replacement parts.
10. Use of a night-light may provide added safety precautions for a child using the upper bunk.
11. If the bunk bed will be placed next to a wall, the guardrail that runs the full length of the bed should be placed against the wall to prevent entrapment between the bed and the wall. (This applies only to bunk beds without two full-length guardrails.)
12. Always use guardrails on both long sides of the upper bunk.
13. The use of water or sleep flotation mattress is prohibited.
14. Keep these instructions for future reference.

STRANGULATION HAZARD

15. Never attach or hang items to any part of the bunk bed that are not designed for use with the bed for example, but not limited to hooks, belts and jump ropes.

SIZE OF MATTRESS AND FOUNDATION

Your Twin bed is designed to use a mattress 37 ½”-38 ½” in width and 74” - 75” in length.

Your Full bed is designed to use a mattress 52”- 54” in width and 74” - 75” in length.

The total thickness of mattress and foundation (slat kit, bunk board, etc.) combined must not exceed **10”**.

Note: There must be at least 5” from mattress sleeping surface to top edge of guardrail.

REPLACEMENT PARTS

Replacement parts, including additional guardrails, may be obtained from your Furniture dealer.



LIVING SPACES

When used with a slot roll, the three individual slats should be placed evenly in the gaps and underneath the strapping before fastening.

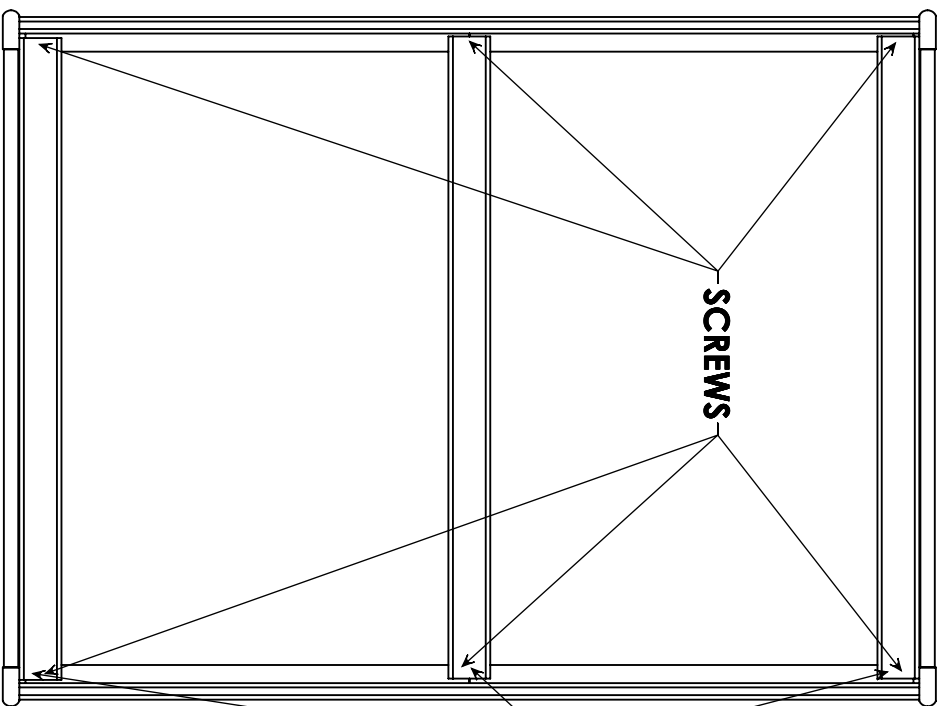

Installation of individual slats for use with Bunkie Board
(Bunkie Board sold separately)
See your retailer for purchase of Bunkie Board

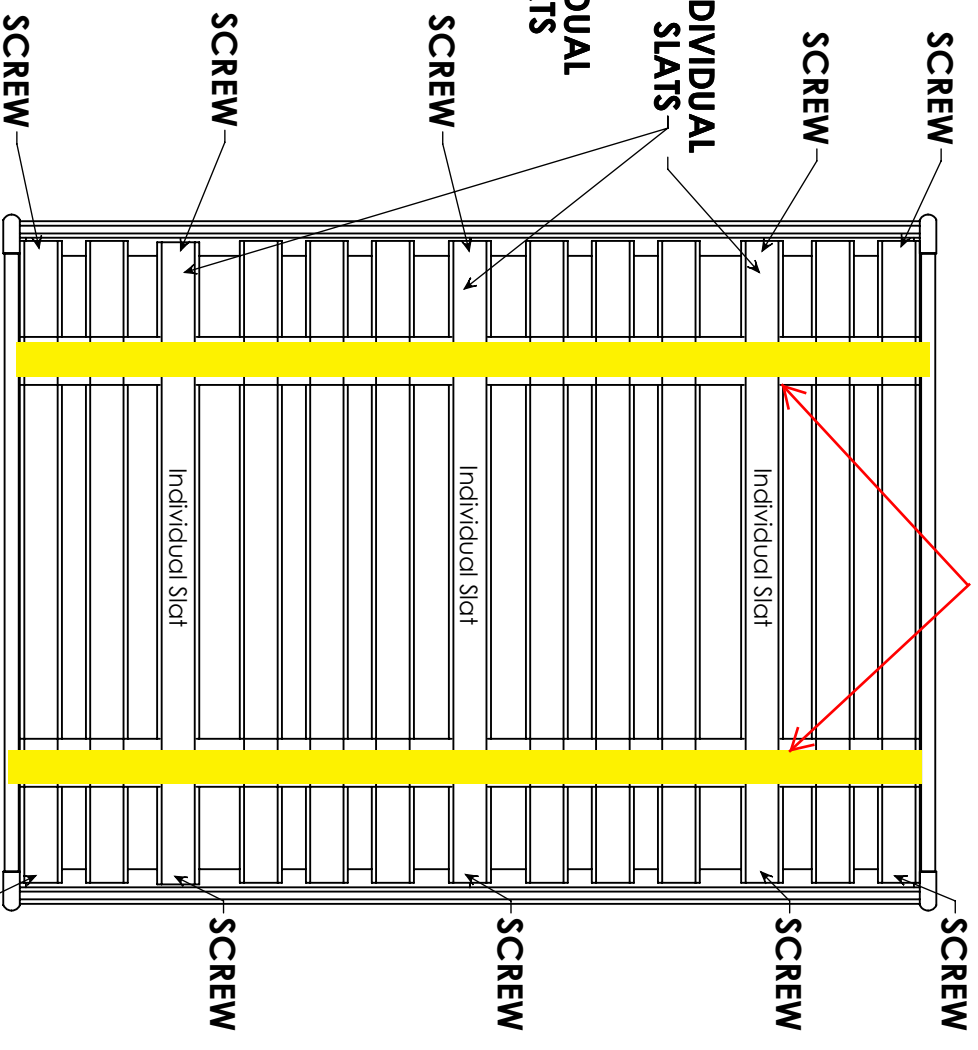

Installation of individual slats for use with Slot Roll
(Slot roll sold separately)
See your retailer for purchase of Slot Roll

STAIRWAY CHEST WITH BUNK BED

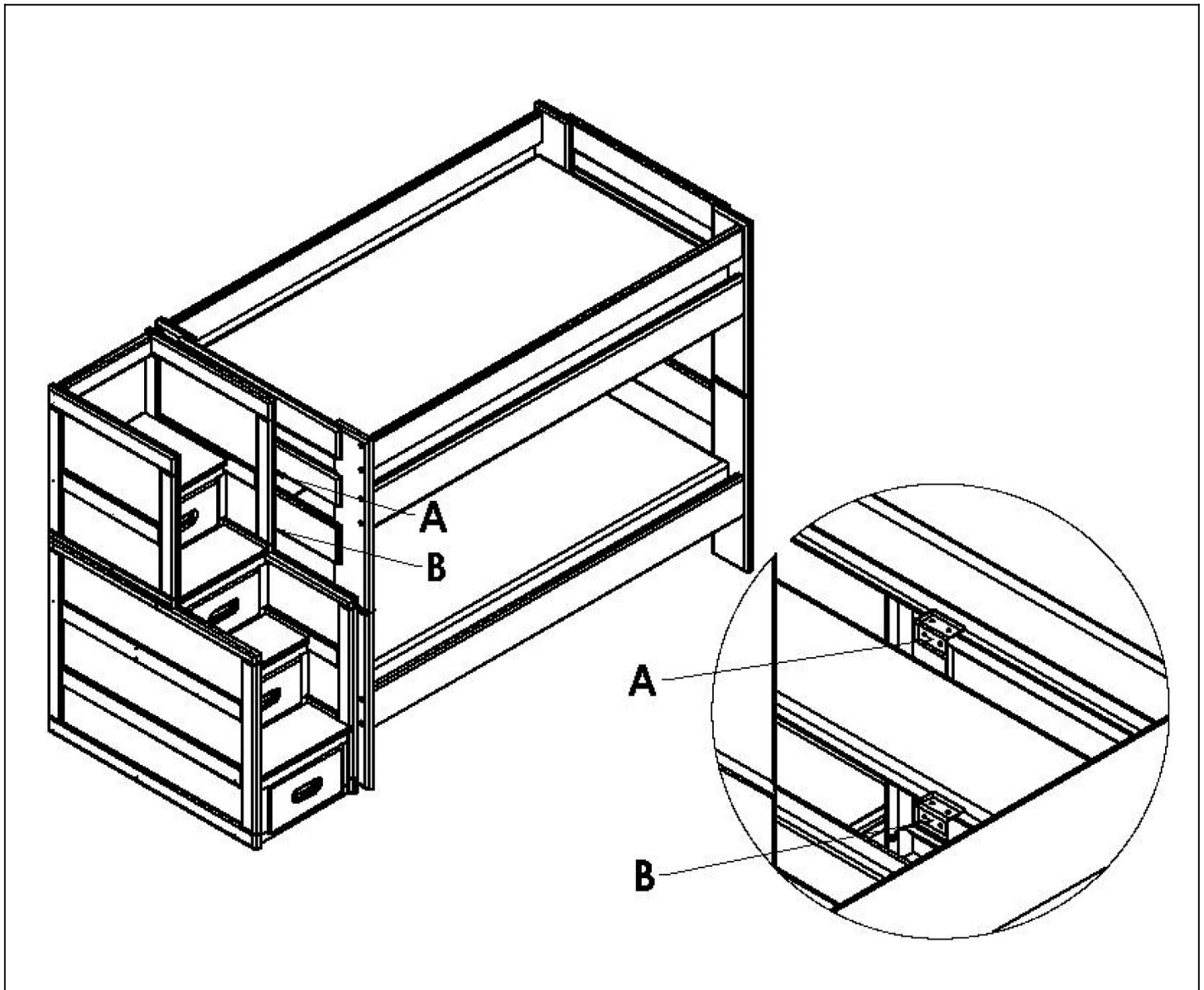

The stairway chest has been designed for use as a free standing unit. However for your convenience, if you desire to attach the stairs to your bunk bed we have included four 2" angle brackets. We recommend using these to attach the top center side vertical of the stairway unit to one or two of the end cross members or side rails of the bunk depending on how you position the stairway. The illustration above demonstrates how the top center vertical might align with the end cross members of a standard Bunk Bed.

PARTS LIST:

- A) 2-2" Angle Brackets
- B) 8-1 1/4" Philips pan head screws

TOOLS REQUIRED:

- 1) Phillips Head Screwdriver