

7030-01245 KIT

For: 4710 Frame Rails/4711 Bunk Ends





(Scan for instructional video)







Sedona Collection: Wrangler Bunk

PARTS LIST

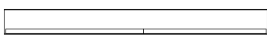
BOX 1: 4710 Wrangler Bunk Ends

Part #	Picture	Description	Quantity
S0003END		Wrangler Bunk Top End	2
S0007END		Wrangler Bunk Bottom End	2

BOX 2: Wrangler Bunk Frame

Part #	Picture	Description	Quantity
S1002SRL		5/4x8 Matress Rail	4
560750001		5/4x6 Guard Rail	2
149383/40		Individual Twin Slat	3
FLDWL		3" Fluted Dowel	4
5040-43181		Hex Lag Bolt/Washer	24
5040-35410		#6 x 1 1/4 Phil Flat Slat Screw	20

Make sure you have all parts before beginning assembly. If you need a part, contact Living Spaces

COMPLETED ASSEMBLY

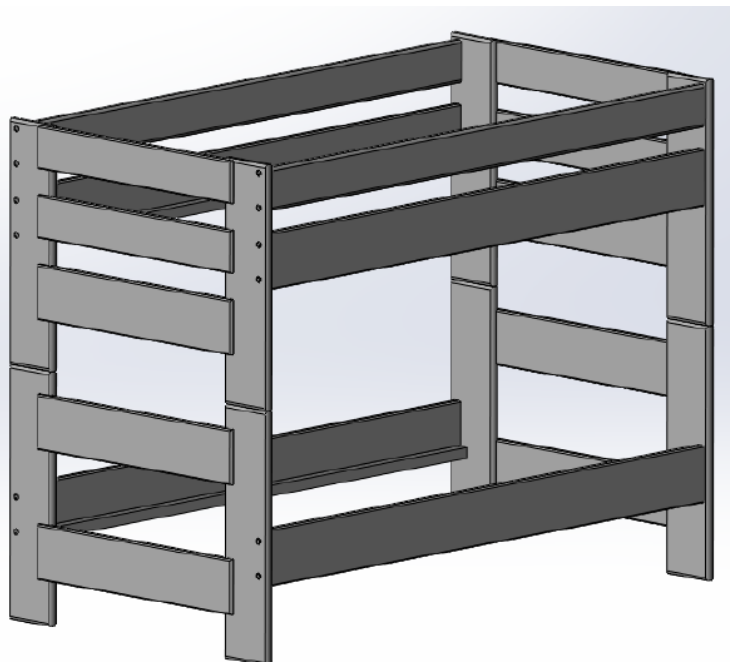

TOOLS REQUIRED:

- 1) 7/16" Wrench or Socket Wrench
- 2) Phillips Head Screwdriver

NOTE: Tool recommended: Electric driver with 7/16" socket

ASSEMBLY INSTRUCTIONS:

NOTE:

Make sure you have all parts before beginning assembly. If you need a part, contact the dealer where you purchased your bed.

- 1) Attach two mattress rails(S1002SRL) to two bottom end assemblies(S0007END) with 8 lag bolts and 8 washers, and tighten.
- 2) Attach two mattress rails(S1002SRL) and two guard rails(560750001) to top end assembly(S0003END) with 16 lag bolts and 16 washers, and tighten.
- 3) Place four wooden dowels (FLDWL) in the four holes in top edge of bottom bunk assembly.
- 4) Place the top bunk assembly on the bottom bunk assembly, ensuring that the dowels are inserted in holes in the top bunk assembly.
- 5) Place slat kit (purchased separately) and 3 individual slats(149383/40) in accordance with the diagram on the last page of these instructions. Attach the 5 designated slats to the mattress rail cleats using the #6x1 1/4" screws(5040-35410).

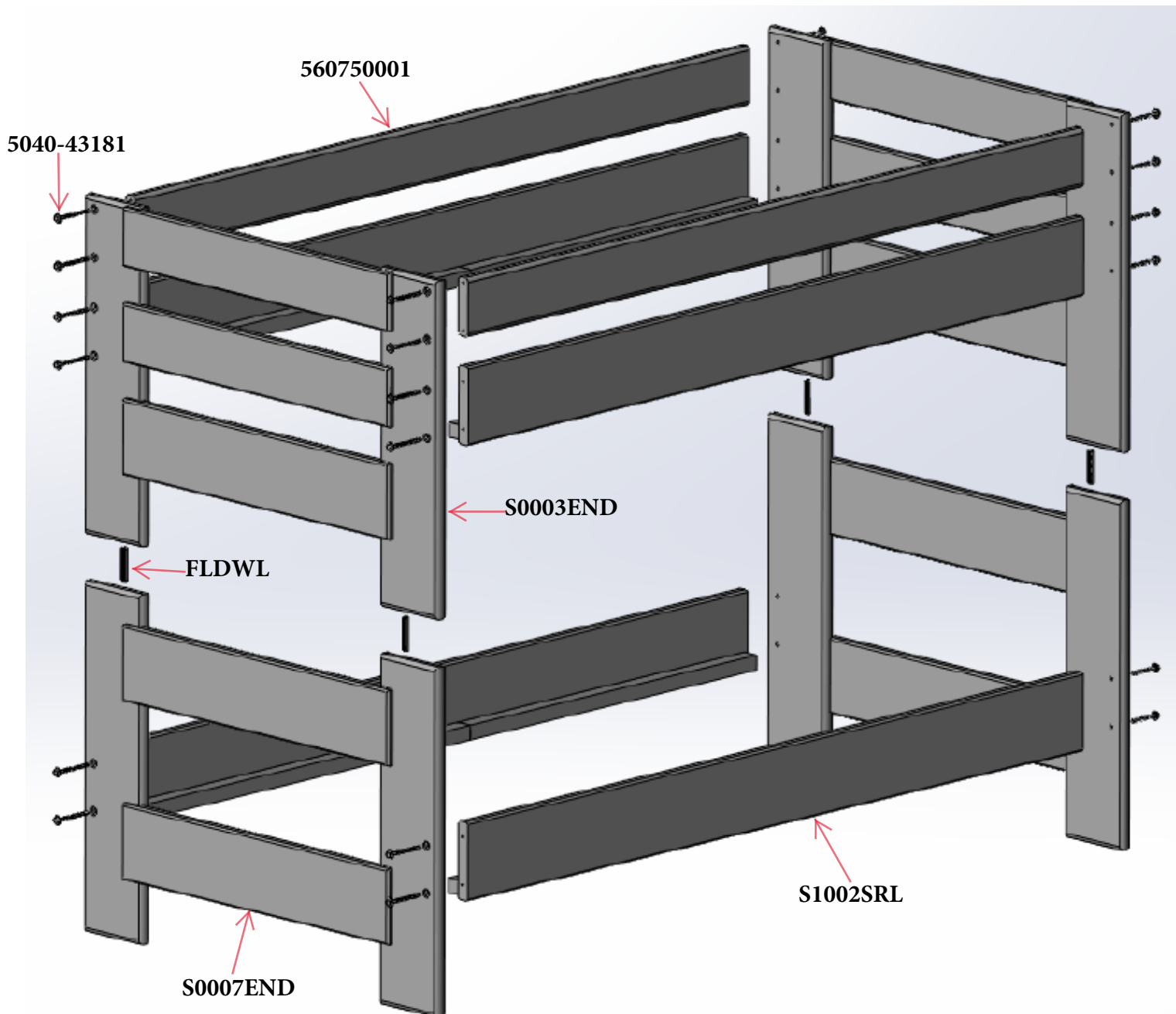

SAFETY WARNING

Our Bunk Beds have been tested by an Independent Laboratory and are certified to be in compliance with: ASTM F-1427, "Standard Consumer Safety Specification for Bunk Beds" and U.S. Government specifications 16 Code of Federal Regulations, parts 1213 and 1513.

SAFETY WARNINGS

1. Follow the information on the warnings attached to the upper bunk end structure and on the carton. Do not remove this label.
2. Always use the recommended size mattress or mattress support, or both, to help prevent the likelihood of entrapment or falls.
3. Surface of mattress must be at least five inches(127mm) below the upper edge of guardrails.
4. Do not allow children less than six years of age to use the upper bunk.
5. Periodically, check and ensure that the guardrail, ladder and other components are in their proper position, free from damage and that all connectors are tight.
6. Do not allow horseplay on or under the bed and prohibit jumping on the bed.
7. Prohibit more than one person on upper bunk.
8. Always use the ladder or bed end for entering and leaving the upper bunk.
9. Do not use substitute parts. Contact manufacturer or dealer for replacement parts.
10. Use of a night-light may provide added safety precautions for a child using the upper bunk.
11. If the bunk bed will be placed next to a wall, the guardrail that runs the full length of the bed should be placed against the wall to prevent entrapment between the bed and the wall. (This applies only to bunk beds without two full-length guardrails.)
12. Always use guardrails on both long sides of the upper bunk.
13. The use of water or sleep flotation mattress is prohibited.
14. Keep these instructions for future reference.

STRANGULATION HAZARD

15. Never attach or hang items to any part of the bunk bed that are not designed for use with the bed for example, but not limited to hooks, belts and jump ropes.

SIZE OF UPPER AND LOWER MATTRESS AND FOUNDATION

* A FOUNDATION IS REQUIRED WITH 3 SLAT CONFIGURATION *

Your Twin bed is designed to use a mattress 37"-39" in width and 74" - 75" in length.

Your Full bed is designed to use a mattress 52"-54" in width and 74" - 75" in length.

The total thickness of mattress and foundation (slat kit, bunk board, etc.) combined must not exceed 7".

Note: There must be at least 5" from mattress sleeping surface to top edge of guardrail.

REPLACEMENT PARTS

Replacement parts, including additional guardrails, may be obtained from your Furniture dealer.

Scan Code for Instructional video



Diagram 1

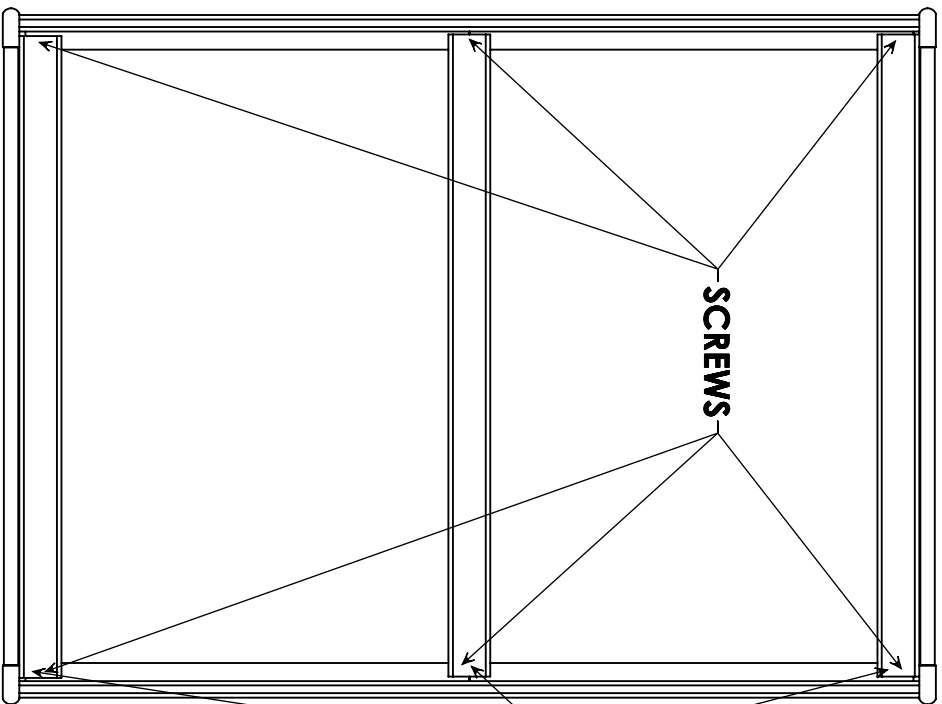

Installation of individual slats for use with Bunkie Board (Bunkie Board sold separately) See your retailer for purchase of Bunkie Board

When used with a slot roll, the three individual slats should be placed evenly in the gaps and underneath the strapping before fastening.

Diagram 2

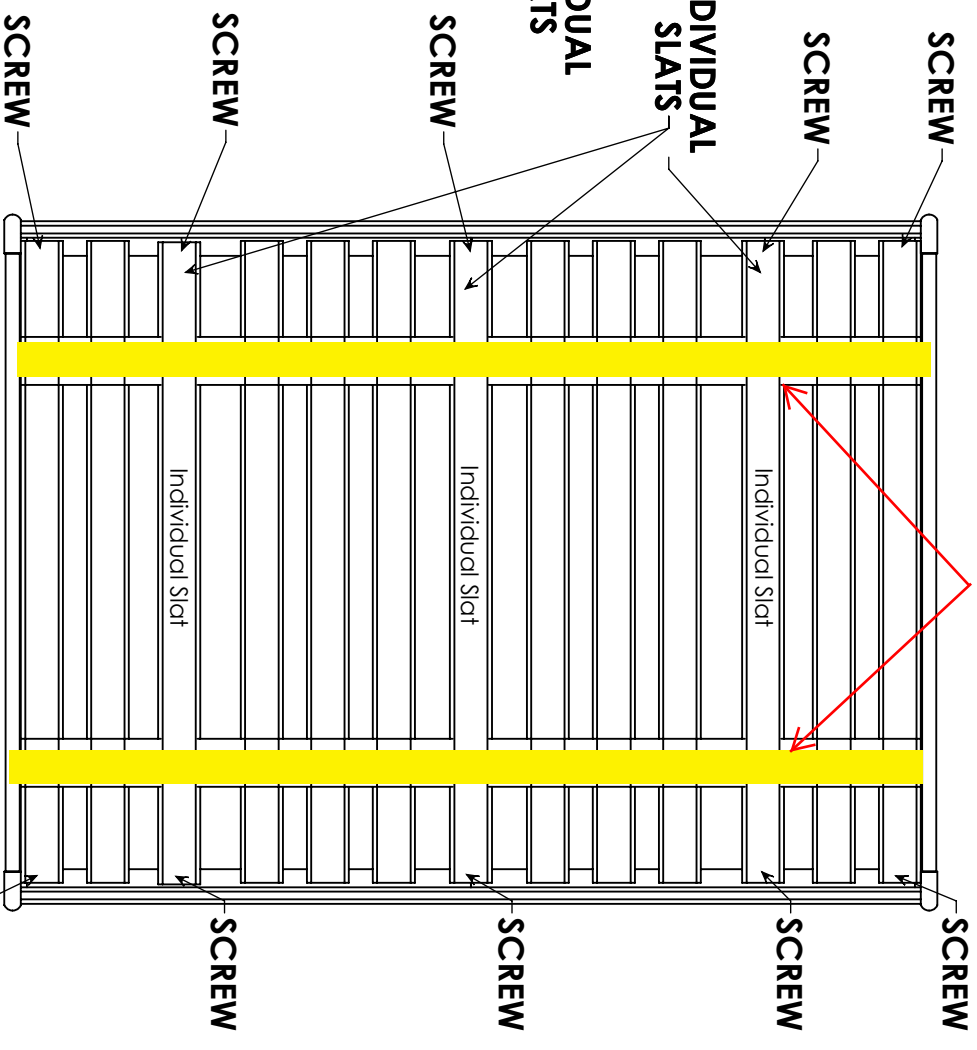

Installation of individual slats for use with Slot Roll (Slot roll sold separately) See your retailer for purchase of Slot Roll

7030-01285 KIT

4466 Trundle



Sedona Collection: Trundle



(Scan code for instructional video)

PARTS LIST

BOX 1: 4466 Sedona Trundle

Part #	Picture	Description	Quantity
4466		Sedona Trundle Assembly	1
5048-00000		Bunkie Mattress	1
5045-65303		Caster Wheel	4
5045-65301		Caster Wheel Insert	4
5043-00205		Sedona Knob	4
5040-35643		1 1/2" Combo Truss Screw	4

Make sure you have all parts before beginning assembly. If you need a part, contact Living Spaces

COMPLETED ASSEMBLY

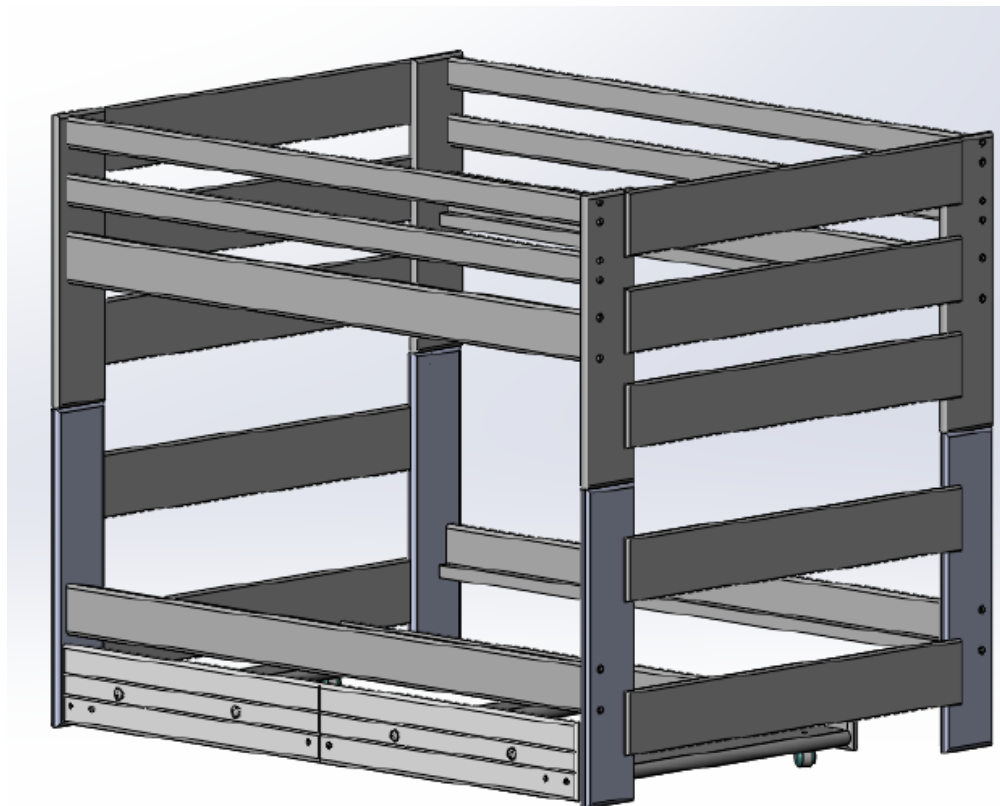

***NOTE: CASTERS HAVE INSERTS WHICH MUST BE DRIVEN FLUSH WITH THE HOLES DRILLED, BEFORE THE CASTERS ARE INSERTED. ATTEMPTING TO DRIVE THE INSERTS IN WITH THE CASTER WHEELS MAY RESULT IN DAMAGE TO THE WHEELS

TOOLS REQUIRED:

NONE

ASSEMBLY INSTRUCTIONS:

- 1) Push the 4 caster inserts into the pre-drilled holes on the bottom of the bed. Make sure the inserts sit flush with the holes and do not protrude. ****Do not attempt to complete step 1 with the caster stems attached to the caster inserts****



- 2) Once all 4 caster inserts are in place, install the caster wheels by pushing the stems of the caster wheels into the inserts and locking them into place. Assembly is complete once all 4 caster wheels have been installed.

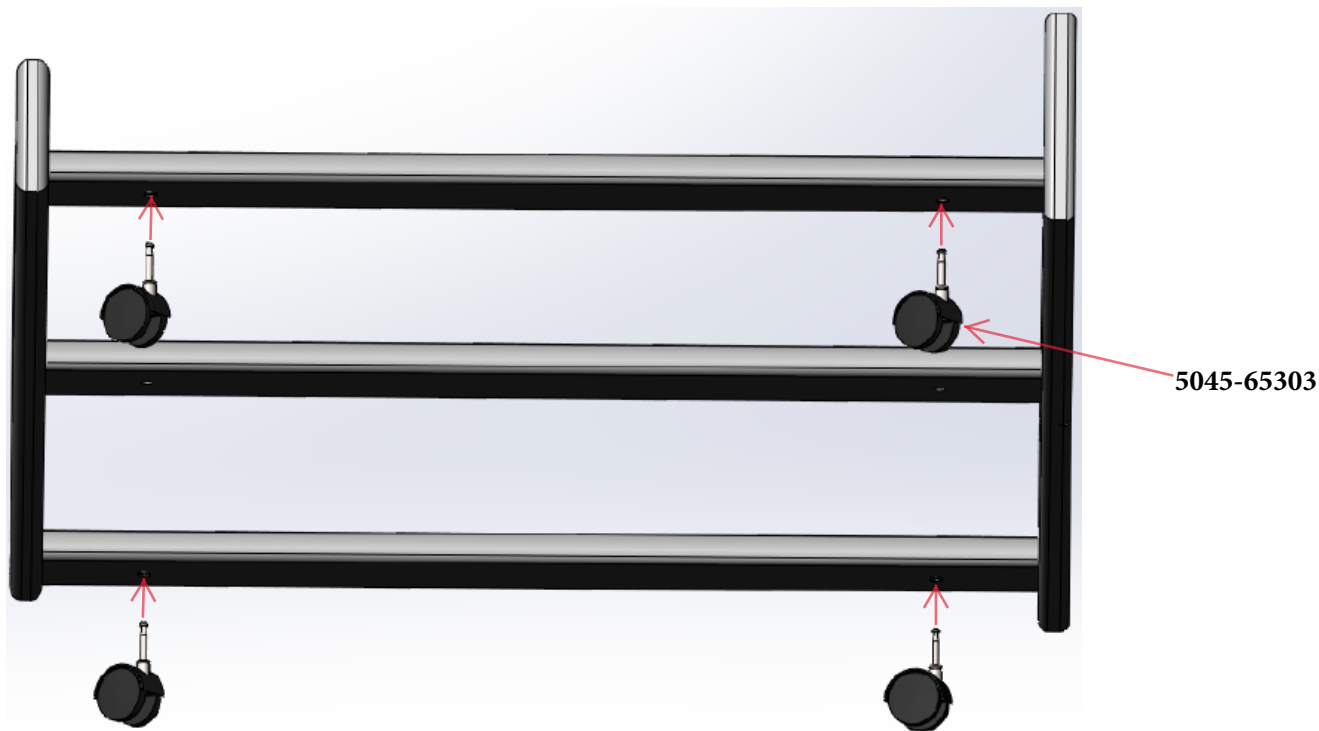

- 3) Attach the 4 Sedona knobs (5043-00415) to the front of your trundle assembly using the pre-drilled holes and the 1 1/2" combo truss screws (5040-35643). Refer to the last page of these instructions for assistance.

- 4) Add bunkie mattress (5048-00000) and push completed trundle bed underneath the bottom bunk for storage, as shown in completed assembly drawing on the front page of these instructions.

7030-01195 KIT



(Scan code for instructional video)

Mateo/Sedona/Summit Collections: Knob and Pull Installation

1. Locate the box containing your knobs and/or pulls in the bottom drawer of your case good.
2. Identify which of the screw sizes is correct for your drawers/doors. The screw should protrude no more than 1/4" when pushed through the pre-drilled holes on your drawers/doors.
3. Push the screw through the back of the pre-drilled hole on the drawer/door and line it up with the thread on the back of the knob/pull.
4. Tighten the screw into the back of the knob/pull until the knob/pull is tight against the front of your drawer/door.

****You can tighten your screws with either a phillips screwdriver, a drill with a phillips bit, or your hand****

