



LIVING SPACES

# ASSEMBLY INSTRUCTIONS

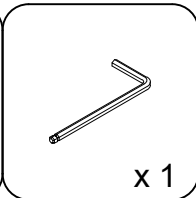
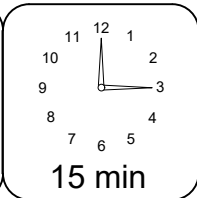
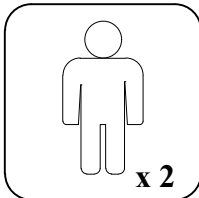
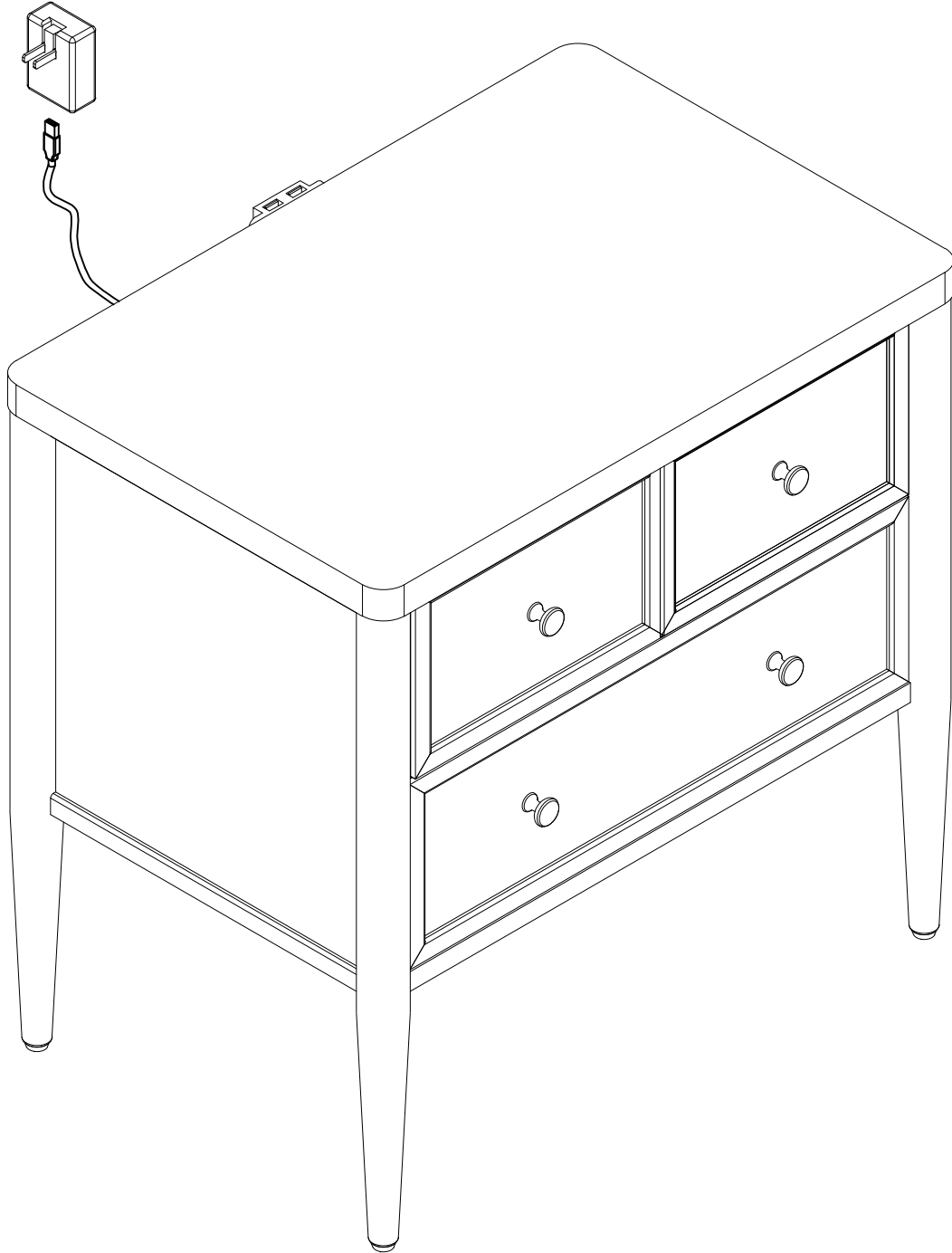

**AUSTEN WHITE 3 DRAWER NIGHTSTAND**  
**ITEM NO: B2101W-103**

**SKU:346042**

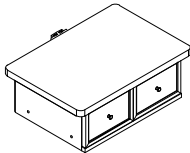
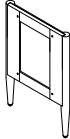
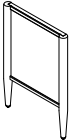

<b>PART</b>	<b>SKU#</b>	<b>IMAGE</b>	<b>DESCRIPTION</b>	<b>QTY</b>
<b>(A)</b>	<b>346042</b>		<b>Desk Top</b>	<b>1</b>
<b>(B)</b>	<b>346042</b>		<b>End assembly Right</b>	<b>1</b>
<b>(C)</b>	<b>346042</b>		<b>End assembly Left</b>	<b>1</b>

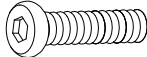
**Hardware List**

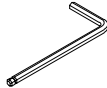
<b>PART</b>	<b>SKU#</b>	<b>IMAGE</b>	<b>DESCRIPTION</b>	<b>QTY</b>
<b>(1)</b>	<b>346042</b>		<b>Bolts 1/4" *35mm</b>	<b>8</b>
<b>(2)</b>	<b>346042</b>		<b>Spring Washer 1/4"*11mm</b>	<b>8</b>
<b>(3)</b>	<b>346042</b>		<b>Flat Washer 1/4"*19mm</b>	<b>8</b>
<b>(4)</b>	<b>346042</b>		<b>Allen key</b>	<b>1</b>

**THE HARDWARE IS LOCATED IN THE PACKING ITEM**

**MUST: TIGHTEN SCREWS PERIODICALLY. WITH USE SCREW  
MAY ENCOME LOOSE CHECK TIGHTNESS OF ALL SCREWS EVERY 6-8  
WEEKS.**

**CLEANING INSTRUCTIONS:**

**After assembly, clean and polish the completed parts if necessary with  
soft cloth and industrial recognized furniture polish.**

STEP 1

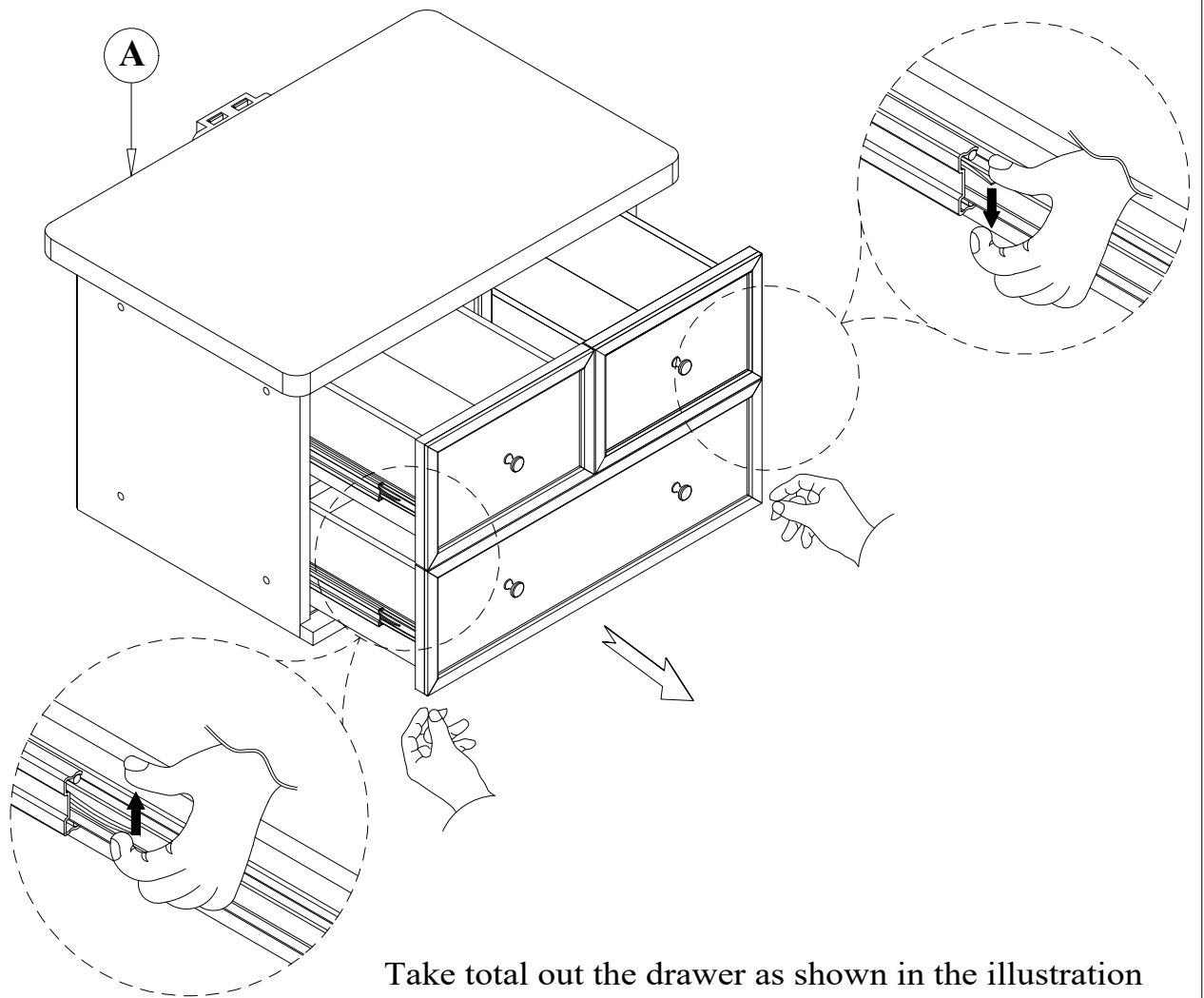

Take total out the drawer as shown in the illustration

STEP 2

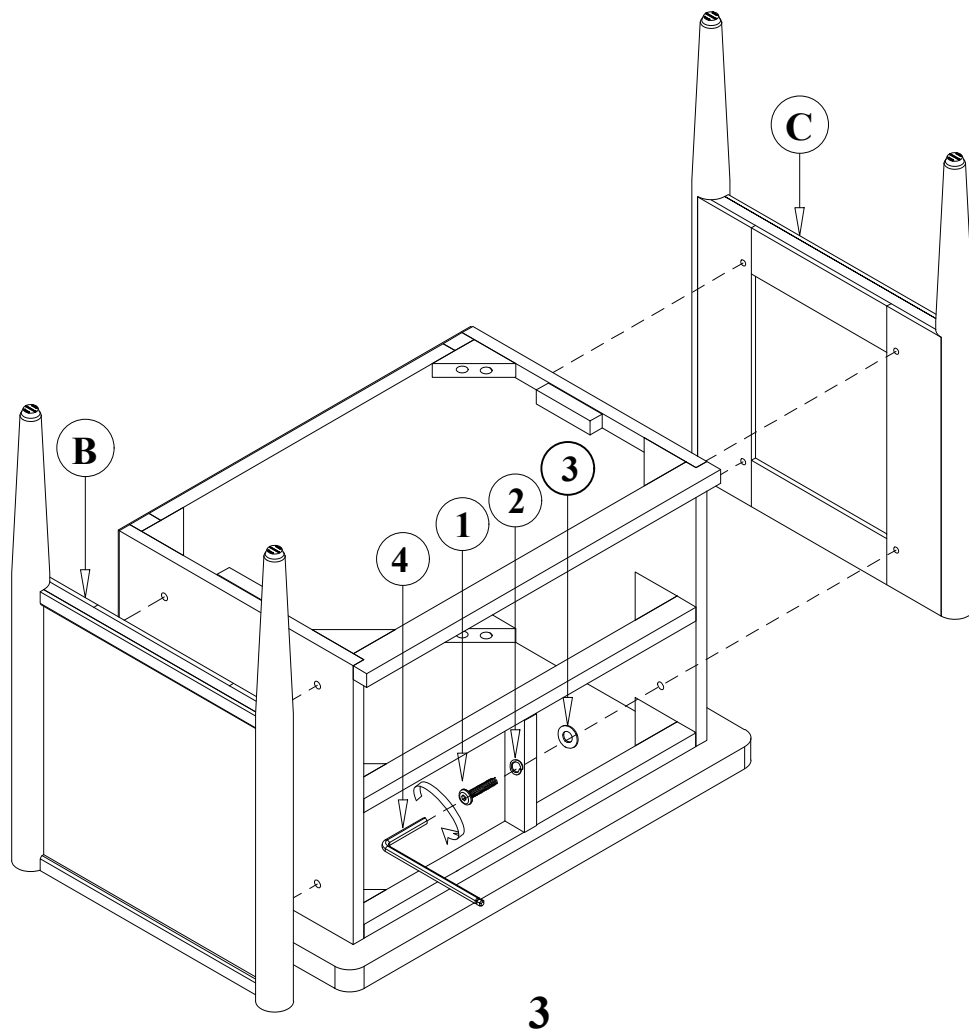

1=8pcs  
2=8pcs  
3=8pcs

**STEP 3**

Install the drawer back as shown in the illustration.

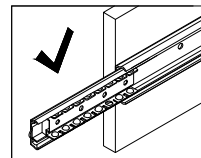
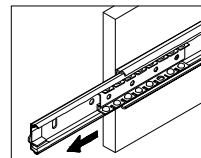
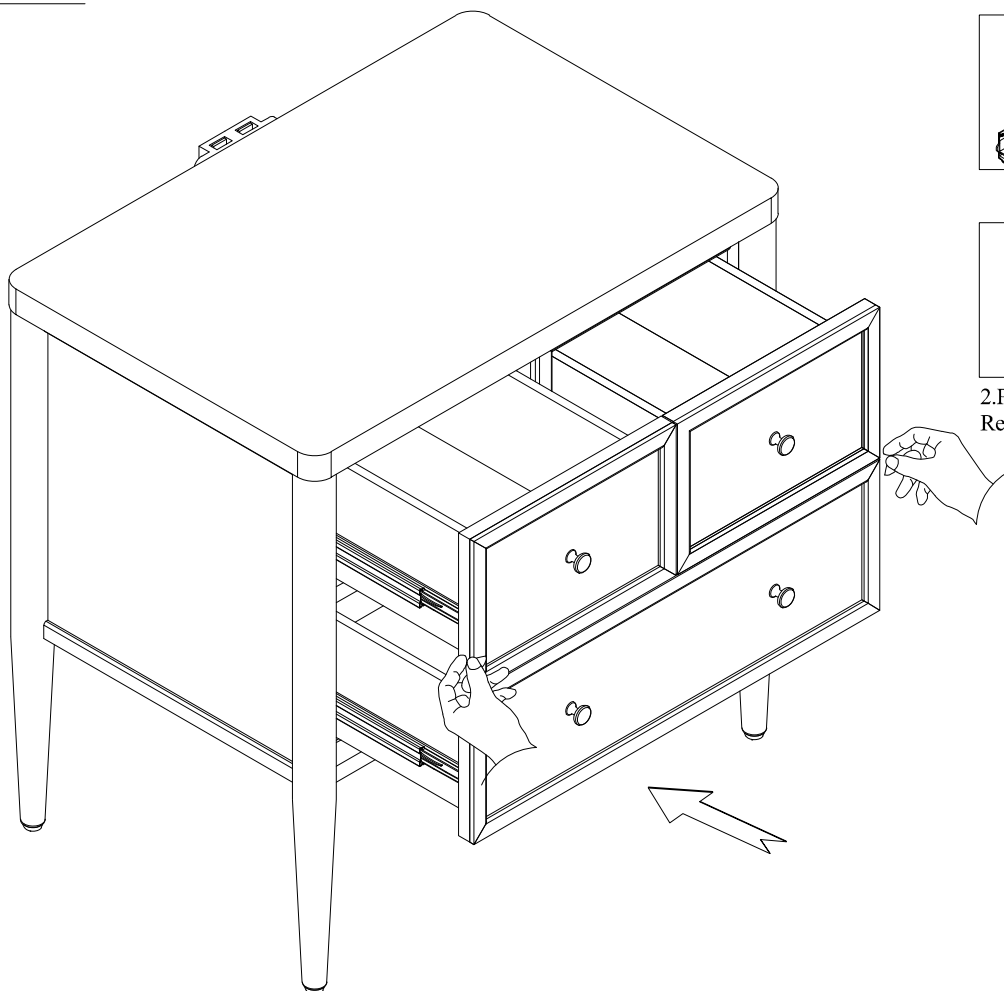

1. Pull out slide. Slide bearings forward

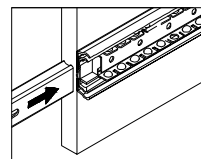
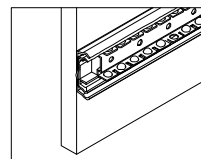

2. Push slide back inside.  
Repeat for every slide

3. Insert into slide  
slot correctly push  
the drawer into the  
table body with force

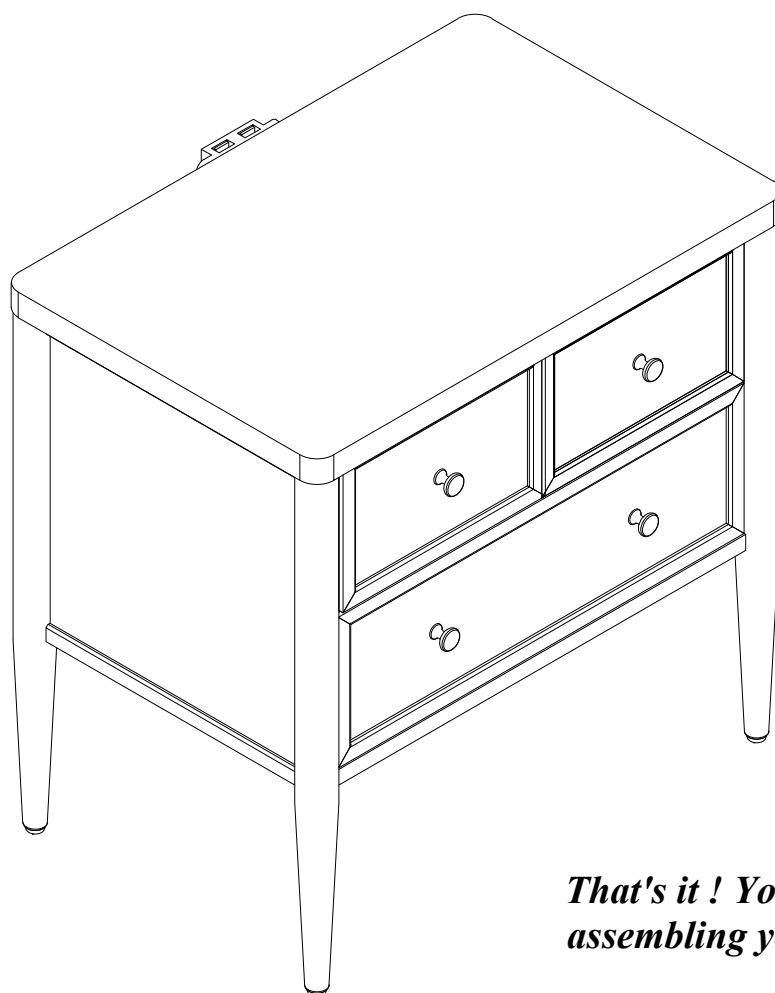

***That's it ! You've finished  
assembling your item. Thank you!***