



LIVING SPACES

ASSEMBLY INSTRUCTIONS

AUSTEN KING UPH BED W/ FOOTBOARD STORAGE

SKU:318034/318025/318057





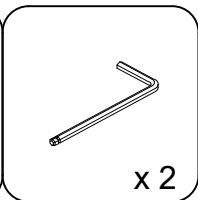
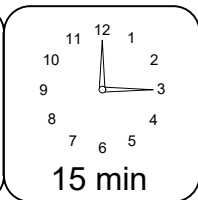
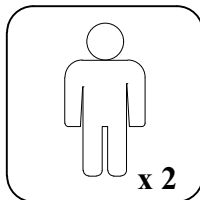
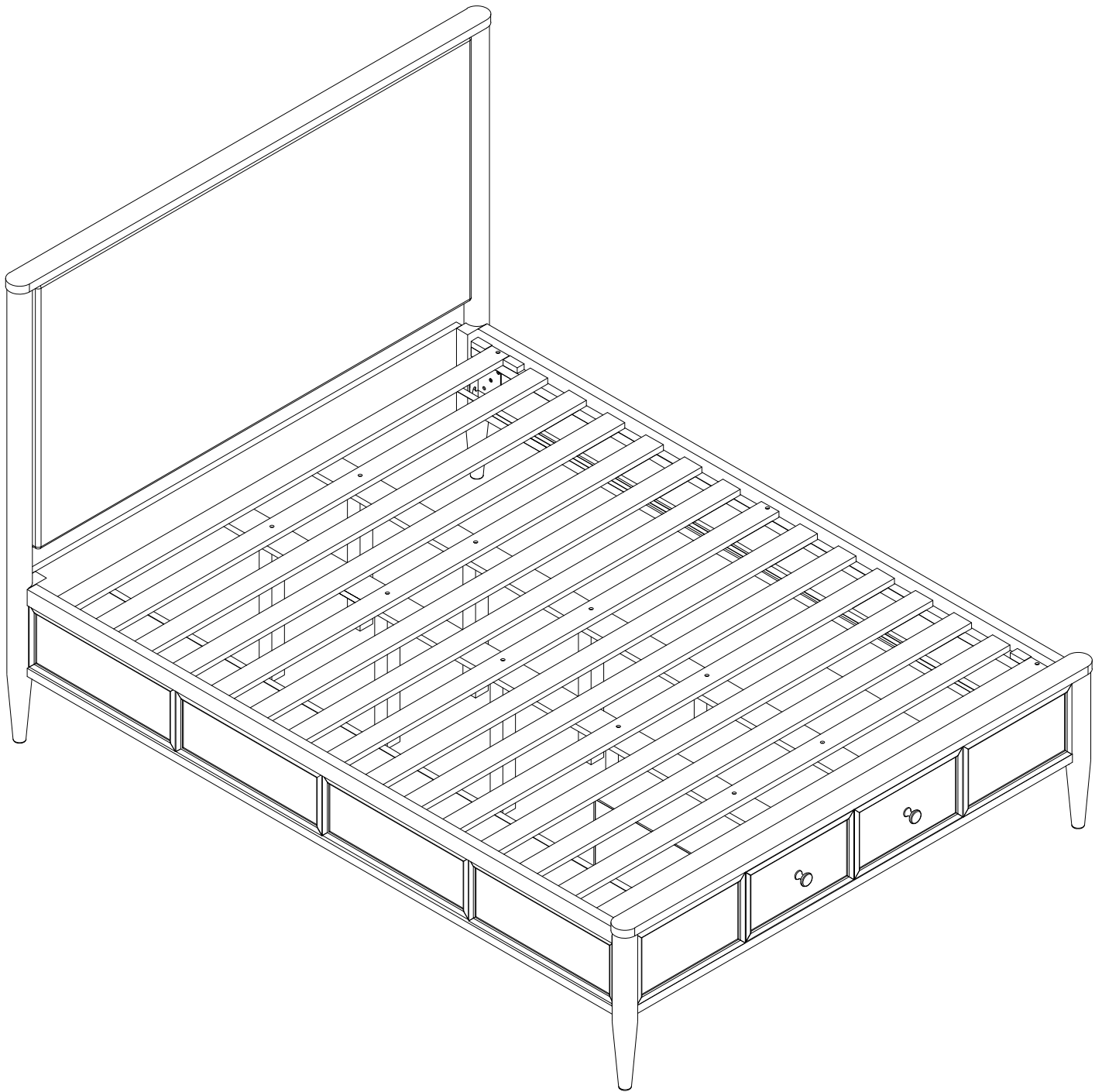

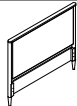
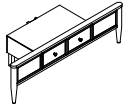
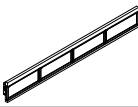
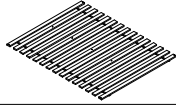
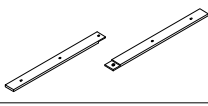
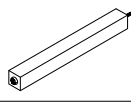
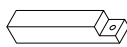
AUSTEN KING PANEL BED W/ FOOTBOARD STORAGE

SKU:337945/318025/318057

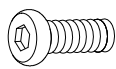

PART	SKU#	IMAGE	DESCRIPTION	QTY
(A)	318034/337945		Head Board	1
(B)	318025		Storage Foot Board	1
(C)	318057		Side Rail	2
(D)	318025		Slat	1 set
(E)	318025		Middle Support Bar	4
(F)	318025		Support With Leveler	10
(G)	318025		Foot Board back leg	2

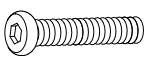
Hardware List

PART	SKU#	IMAGE	DESCRIPTION	QTY
(1)	318057		Bolts 5/16" *25mm	8
(2)	318057		Spring Washer 5/16" Dia	8
(3)	318057		Flat Washer 5/16" * Dia	8
(4)	318025/318057		Allen key	2
(5)	318025		Screw #8* 30mm	6
(6)	318025		Bolts 1/4" *38mm	2
(7)	318025		Spring Washer 1/4"*11mm	2
(8)	318025		Flat Washer 1/4" *19mm	2

THE HARDWARE IS LOCATED IN THE PACKING ITEM

MUST: TIGHTEN SCREWS PERIODIACLLY. WITH USE SCREW MAY ENCOME LOOSE CHECK TIGHTNESS OF ALL SCREWS EVERY 6-8 WEEKS.

CLEANING INSTRUCTIONS:

After assembly, clean and polish the completed parts if necessary with soft cloth and industrial recognized furniture polish.

STEP 1

6=2pcs
7=2pcs
8=2pcs

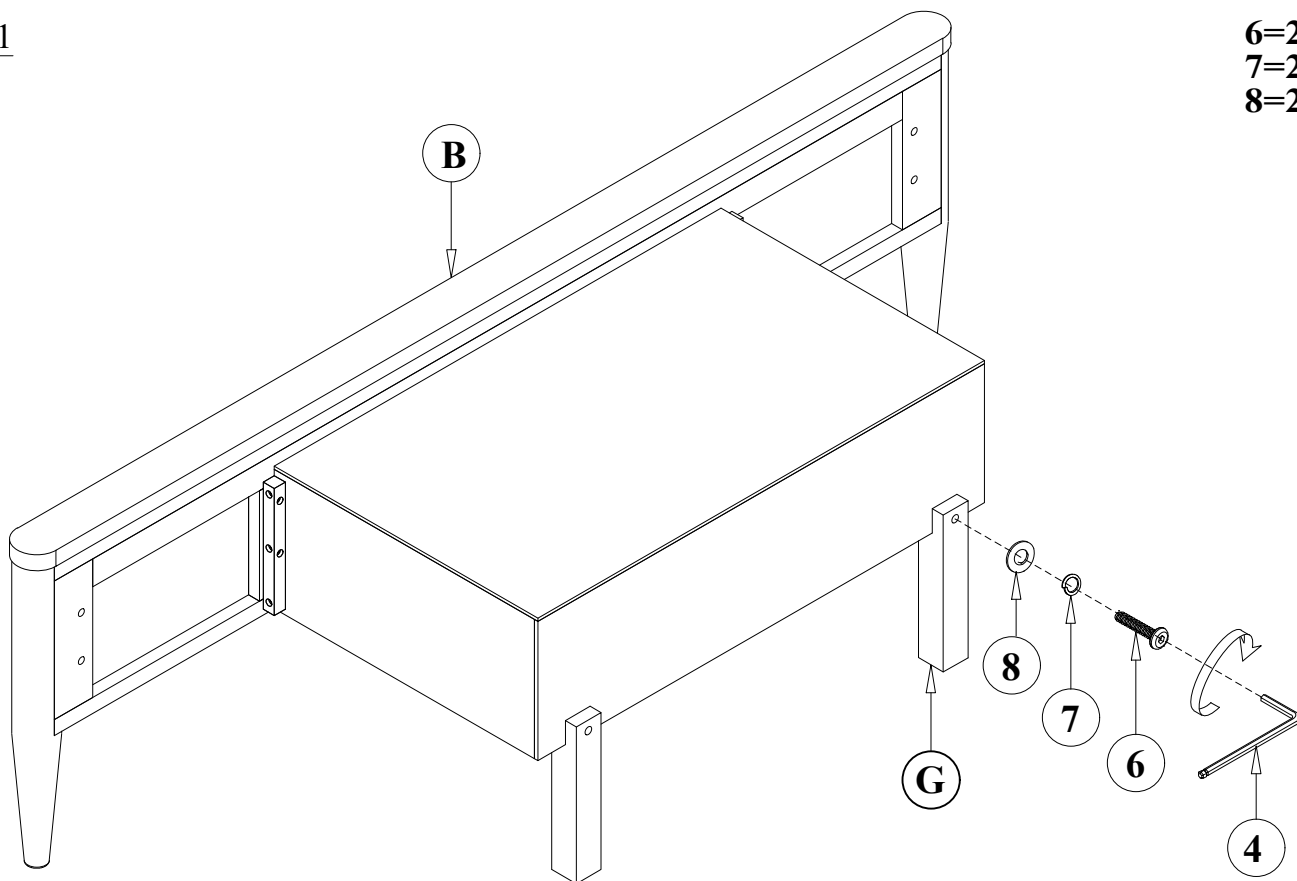

STEP 2

1=8pcs
2=8pcs
3=8pcs

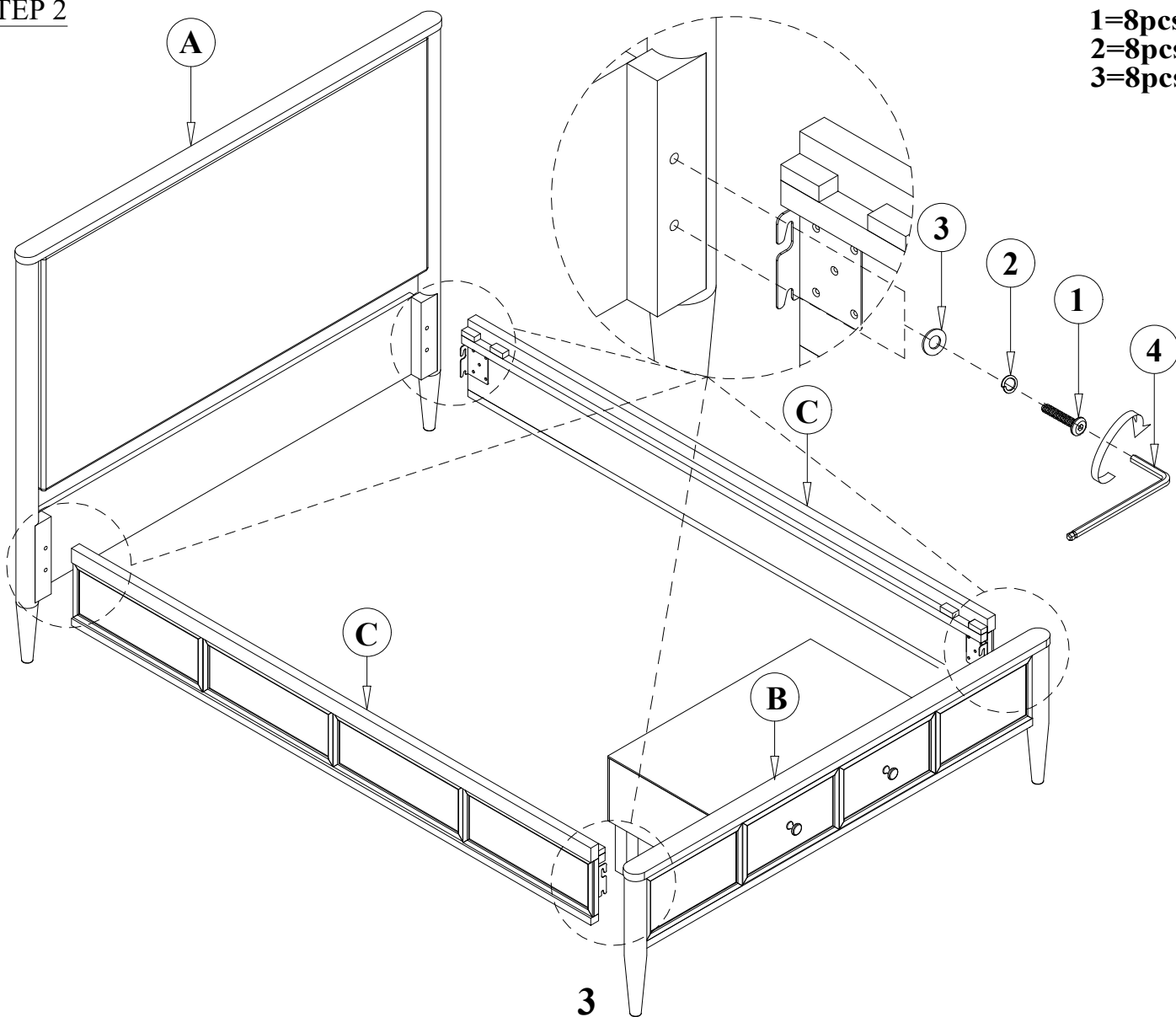

STEP 3

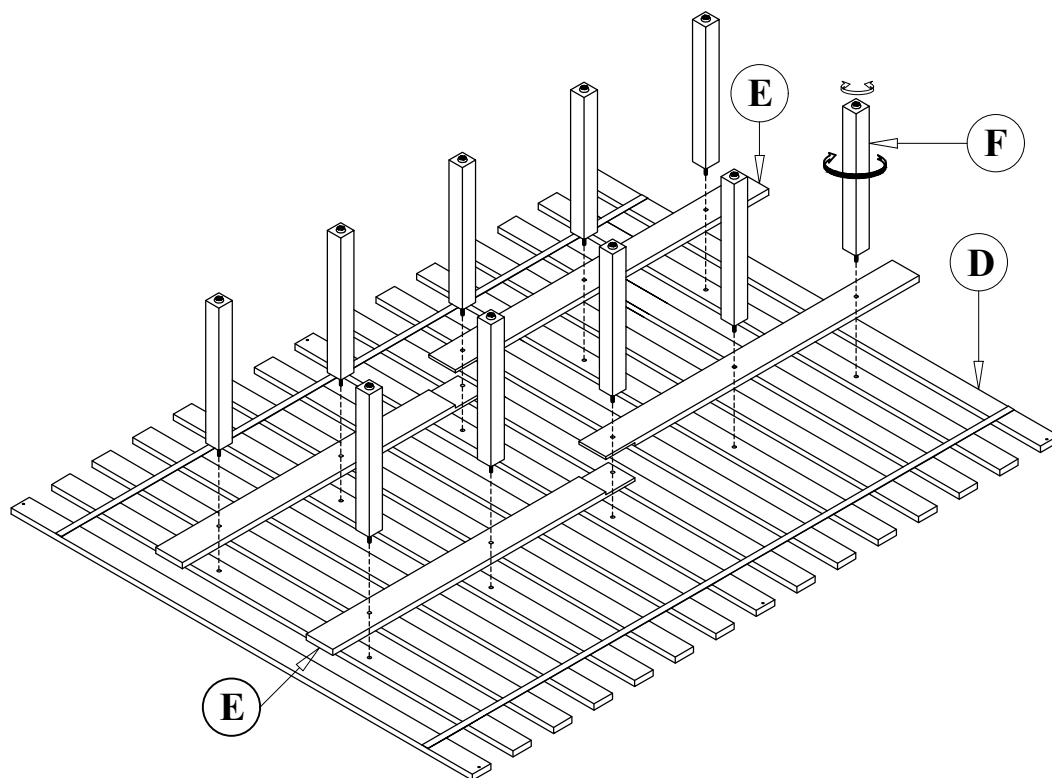

STEP 4

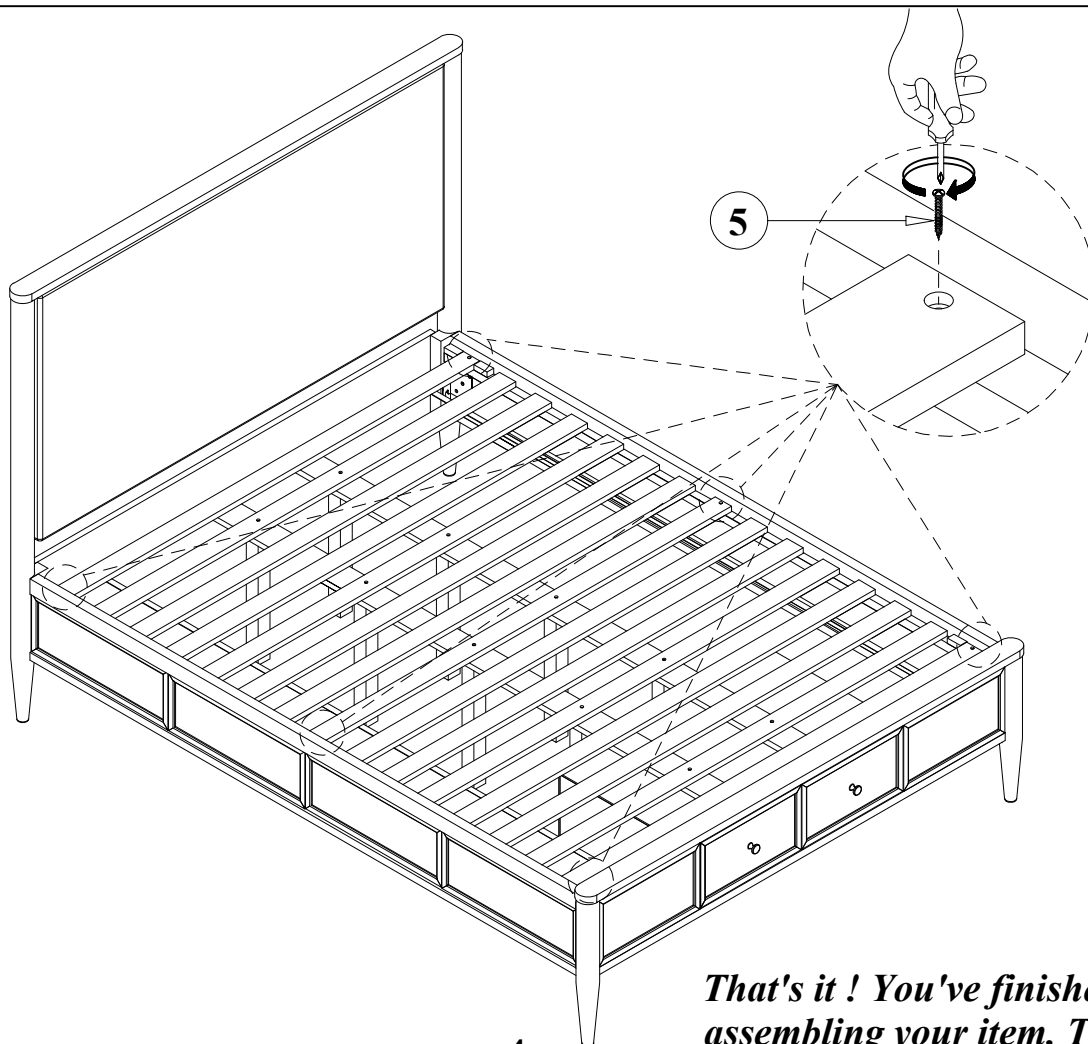

5=6pcs

That's it ! You've finished assembling your item. Thank you!