



LIVING SPACES

ASSEMBLY INSTRUCTIONS

AUSTEN KING UPH BED W/ SIDE STORAGE

SKU:318034/318024/318056

AUSTEN KING PANEL BED W/ SIDE STORAGE



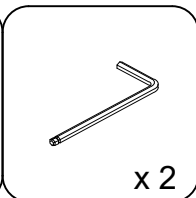
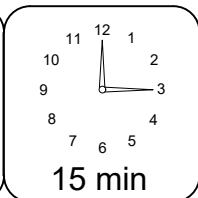
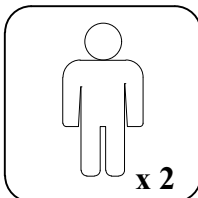
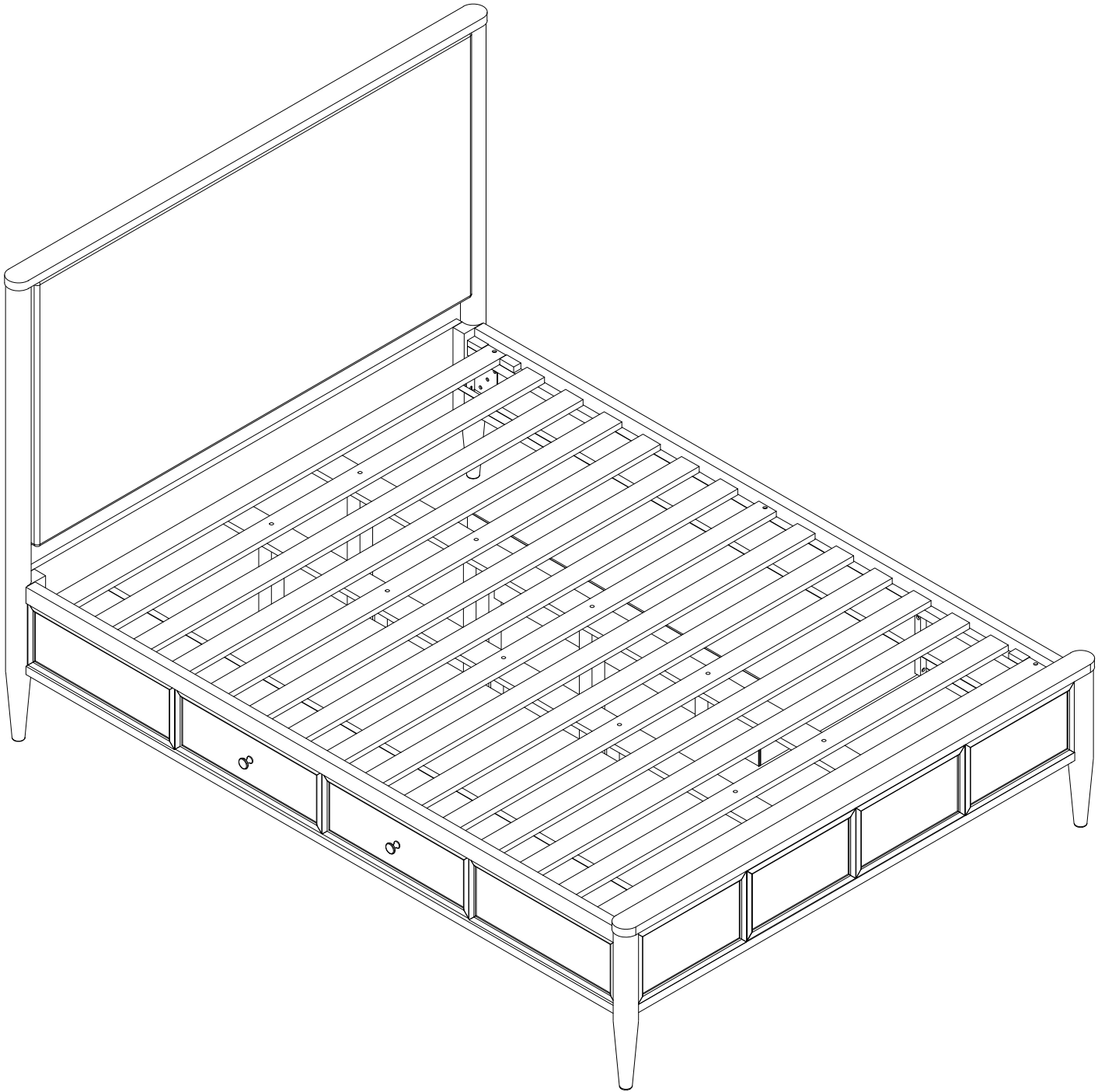

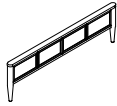
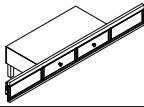
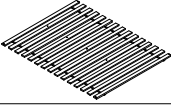
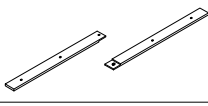
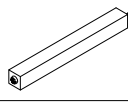
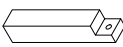

SKU:337945/318024/318056

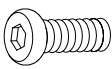

1

PART	SKU#	IMAGE	DESCRIPTION	QTY
(A)	318034/337945		Head Board	1
(B)	318024		Foot Board	1
(C)	318056		Storage Side Rail	2
(D)	318024		Slat	1 set
(E)	318024		Middle Support Bar	4
(F)	318024		Support With Leveler	10
(G)	318056		Side Rail back leg	4

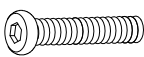
Hardware List

PART	SKU#	IMAGE	DESCRIPTION	QTY
(1)	318056		Bolts 5/16" *25mm	8
(2)	318056		Spring Washer 5/16" Dia	8
(3)	318056		Flat Washer 5/16" * Dia	8
(4)	318056		Allen key	2
(5)	318024		Screw #8* 30mm	6
(6)	318056		Bolts 1/4" *38mm	4
(7)	318056		Spring Washer 1/4"*11mm	4
(8)	318056		Flat Washer 1/4" *19mm	4

THE HARDWARE IS LOCATED IN THE PACKING ITEM

MUST: TIGHTEN SCREWS PERIODIACLLY. WITH USE SCREW MAY ENCOME LOOSE CHECK TIGHTNESS OF ALL SCREWS EVERY 6-8 WEEKS.

CLEANING INSTRUCTIONS:

After assembly, clean and polish the completed parts if necessary with soft cloth and industrial recognized furniture polish.

STEP 1

6=4pcs
7=4pcs
8=4pcs

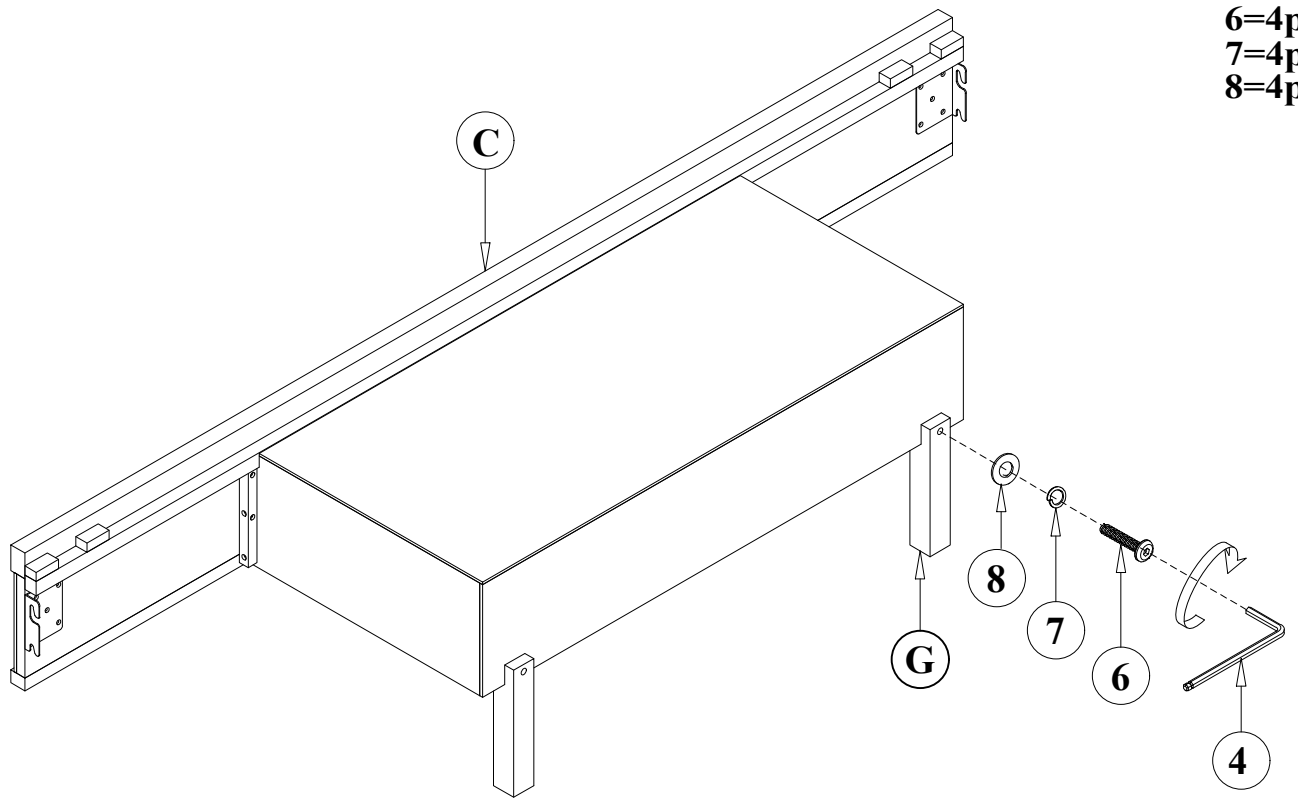

STEP 2

1=8pcs
2=8pcs
3=8pcs

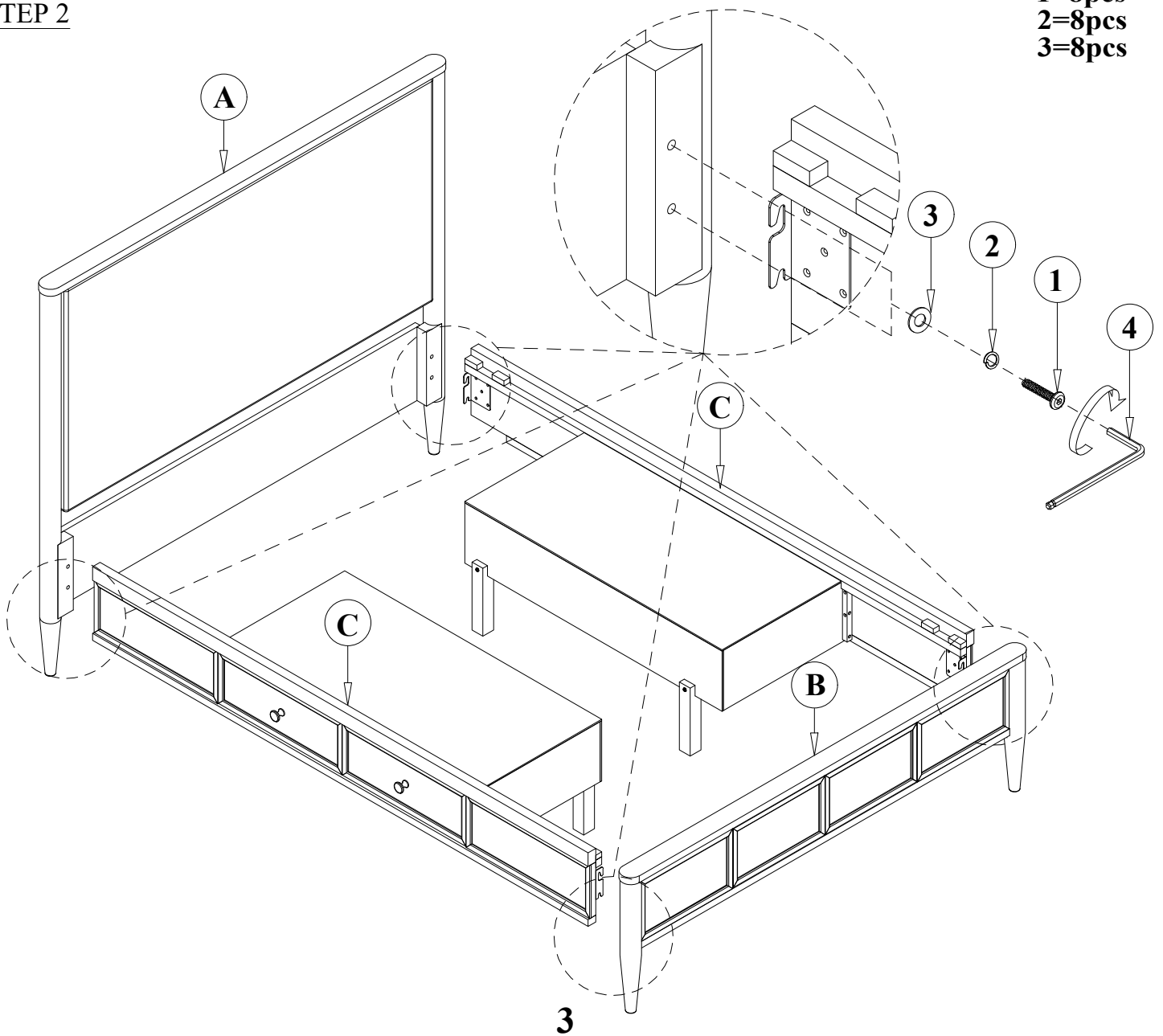

STEP 3

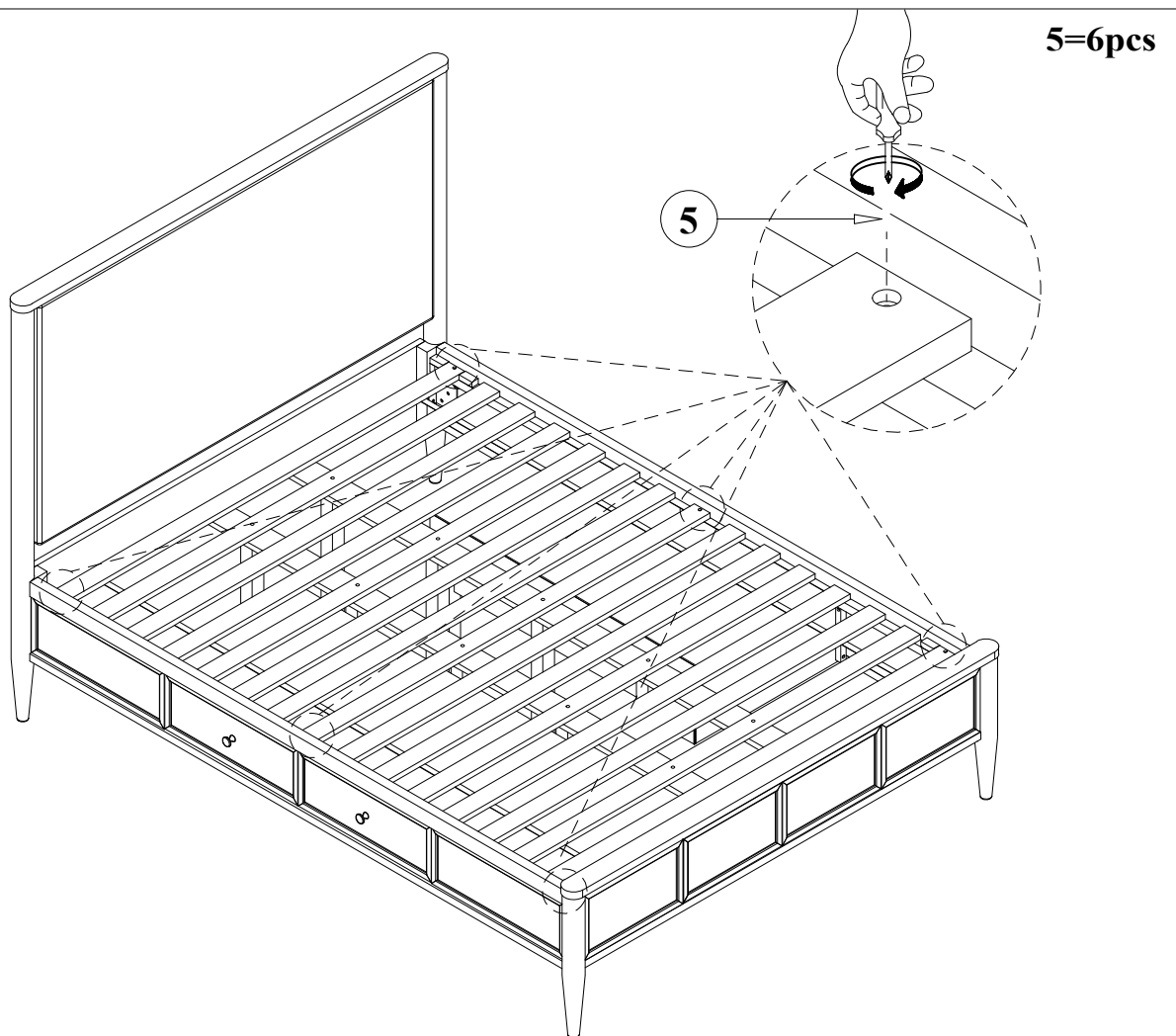
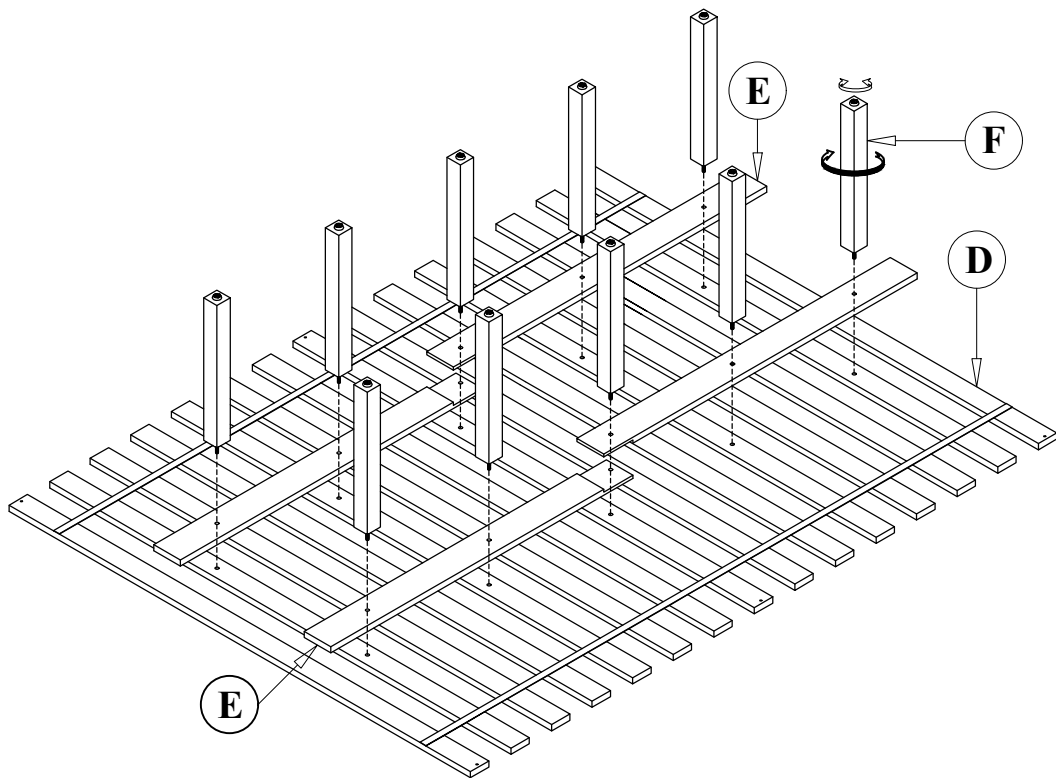

That's it ! You've finished assembling your item. Thank you!