



LIVING SPACES

ASSEMBLY INSTRUCTIONS

AUSTEN QUEEN UPH BED W/ FOOTBOARD STORAGE

SKU:318023/318018/318057





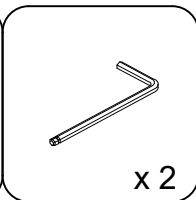
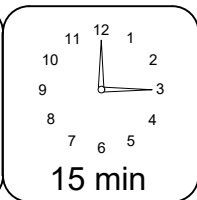
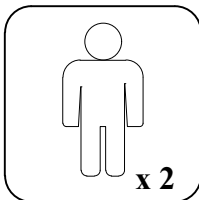
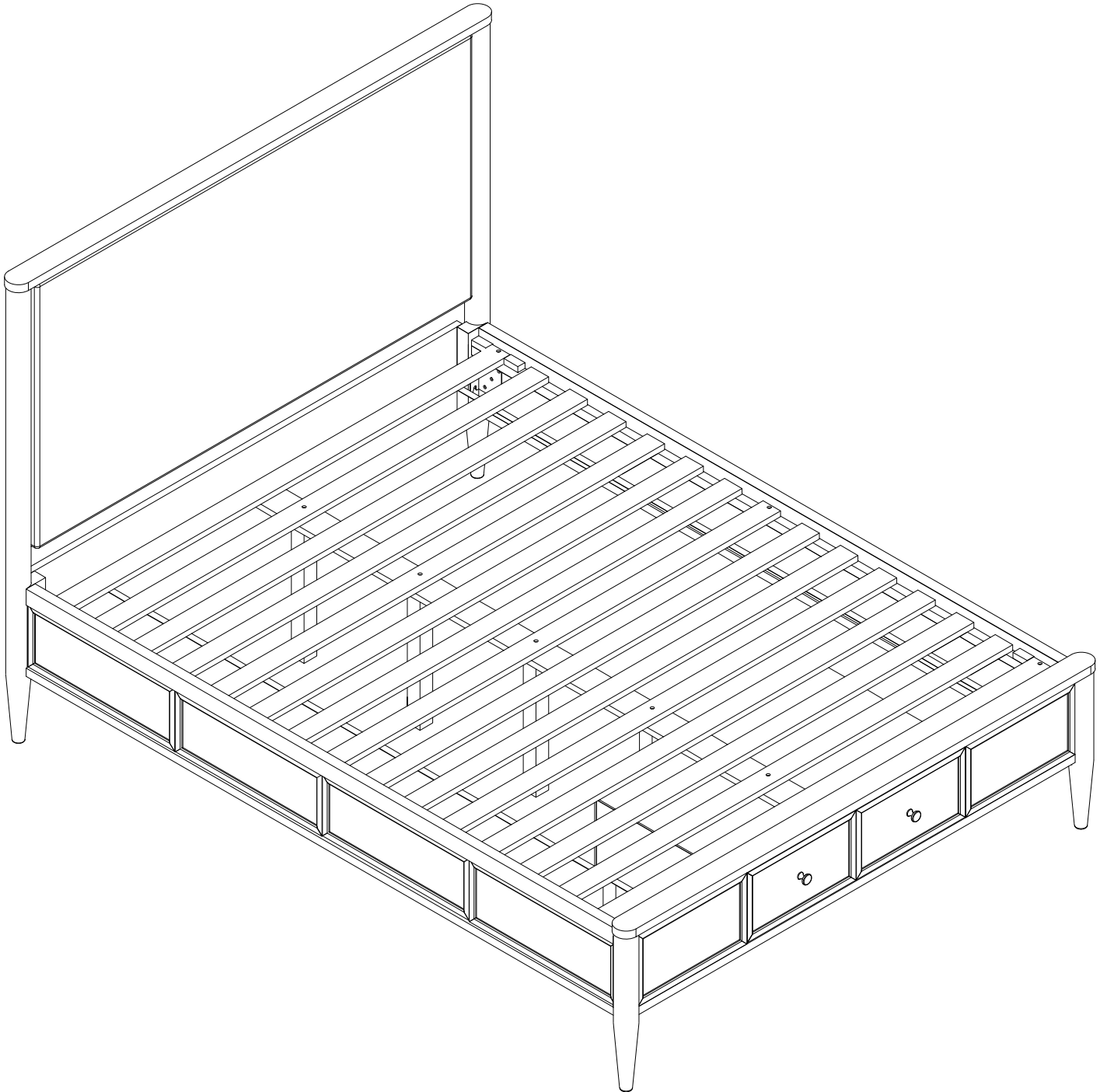

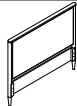
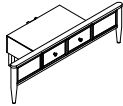
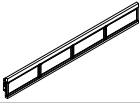
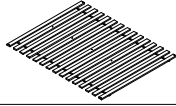
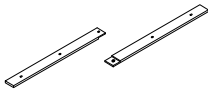
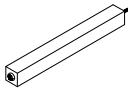
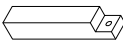
AUSTEN QUEEN PANEL BED W/ FOOTBOARD STORAGE

SKU:337936/318018/318057

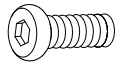

PART	SKU#	IMAGE	DESCRIPTION	QTY
(A)	318023/337936		Head Board	1
(B)	318018		Storage Foot Board	1
(C)	318057		Side Rail	2
(D)	318018		Slat	1 set
(E)	318018		Middle Support Bar	2
(F)	318018		Support With Leveler	5
(G)	318018		Foot Board back leg	2

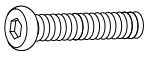
Hardware List

PART	SKU#	IMAGE	DESCRIPTION	QTY
(1)	318057		Bolts 5/16" *25mm	8
(2)	318057		Spring Washer 5/16" Dia	8
(3)	318057		Flat Washer 5/16" * Dia	8
(4)	318018/318057		Allen key	2
(5)	318018		Screw #8* 30mm	6
(6)	318018		Bolts 1/4" *38mm	2
(7)	318018		Spring Washer 1/4"*11mm	2
(8)	318018		Flat Washer 1/4" *19mm	2

THE HAEDWARE IS LOCATED IN THE PACKING ITEM

MUST: TIGHTEN SCREWS PERIODIACLLY. WITH USE SCREW MAY ENCOME LOOSE CHECK TIGHTNESS OF ALL SCREWS EVERY 6-8 WEEKS.

CLEANING INSTRUCTIONS:

After assembly, clean and polish the completed parts if necessary with soft cloth and industrial recognized furniture polish.

STEP 1

6=2pcs
7=2pcs
8=2pcs

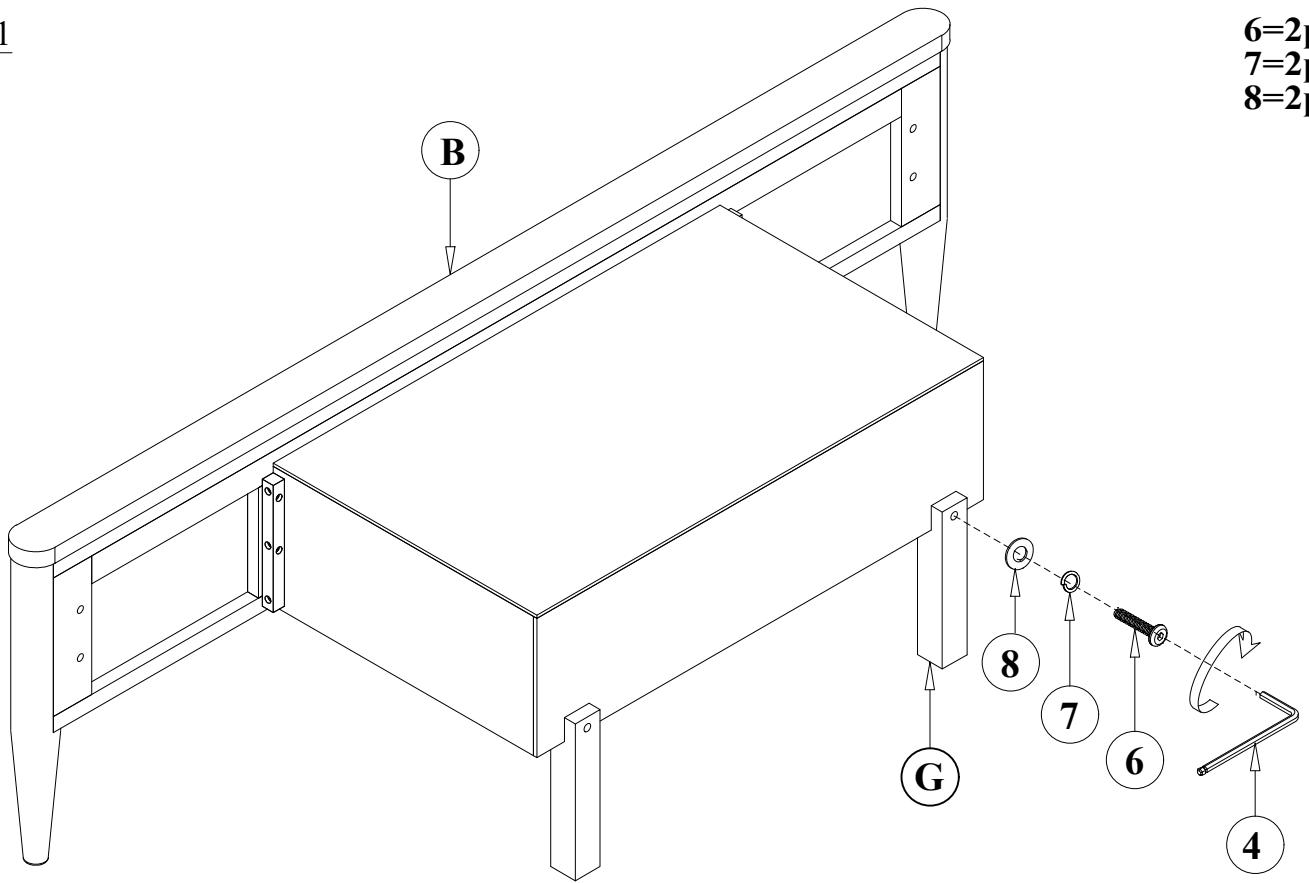

STEP 2

1=8pcs
2=8pcs
3=8pcs

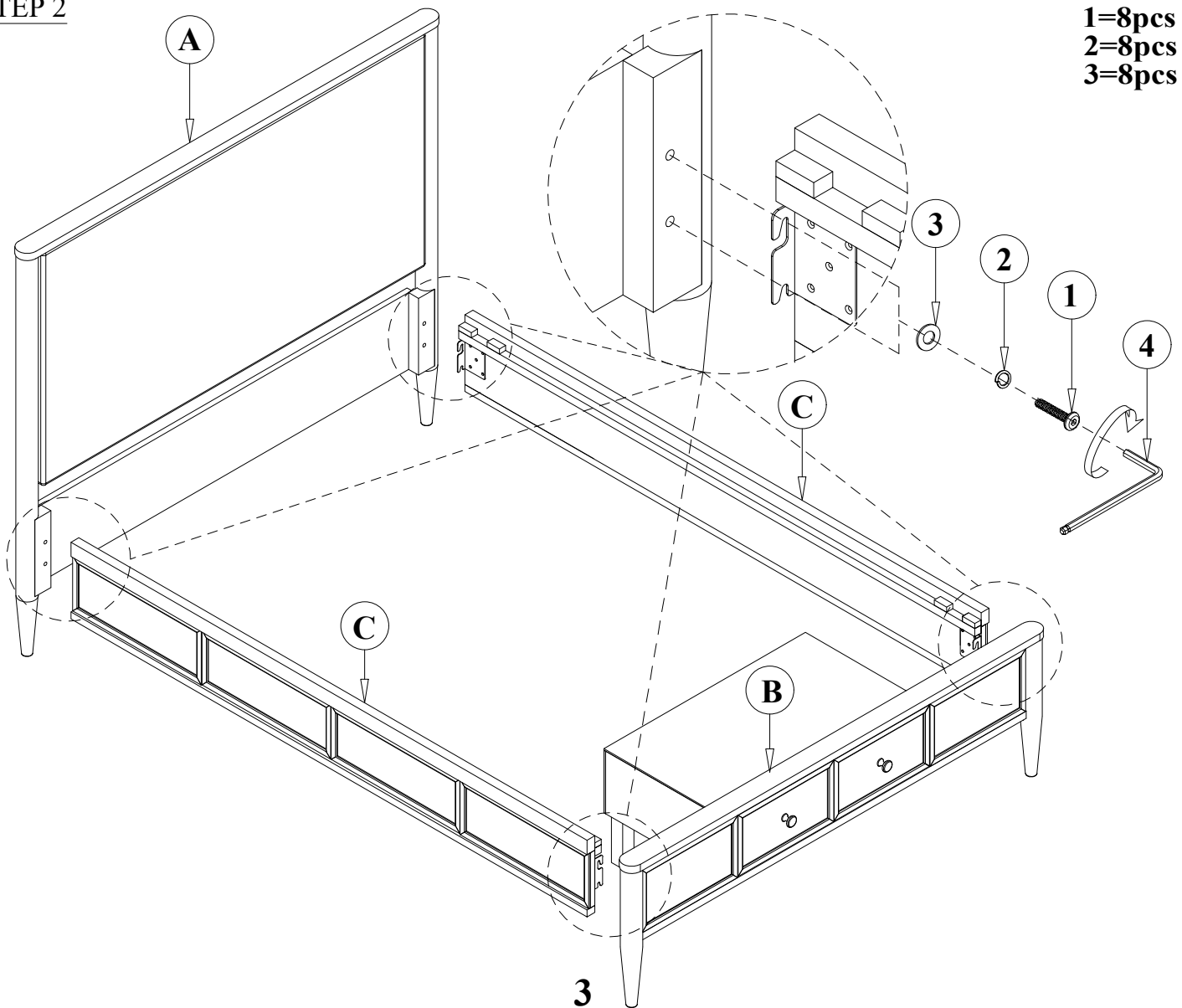

STEP 3

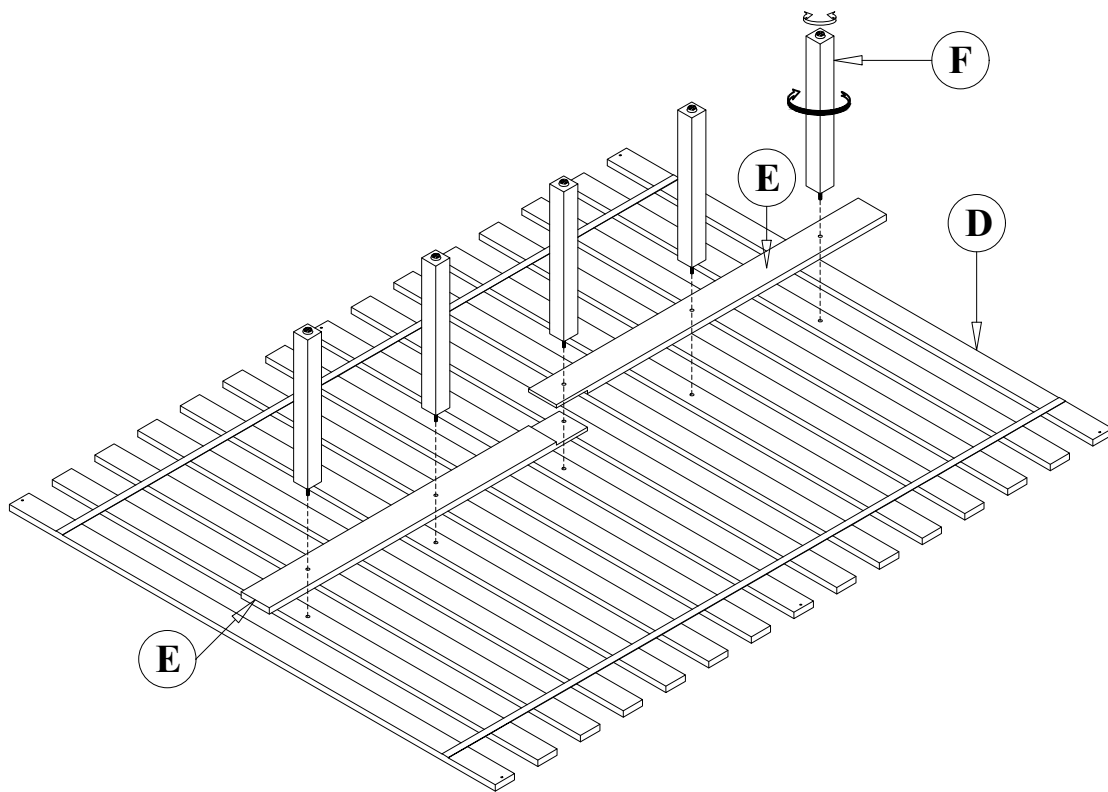

STEP 4

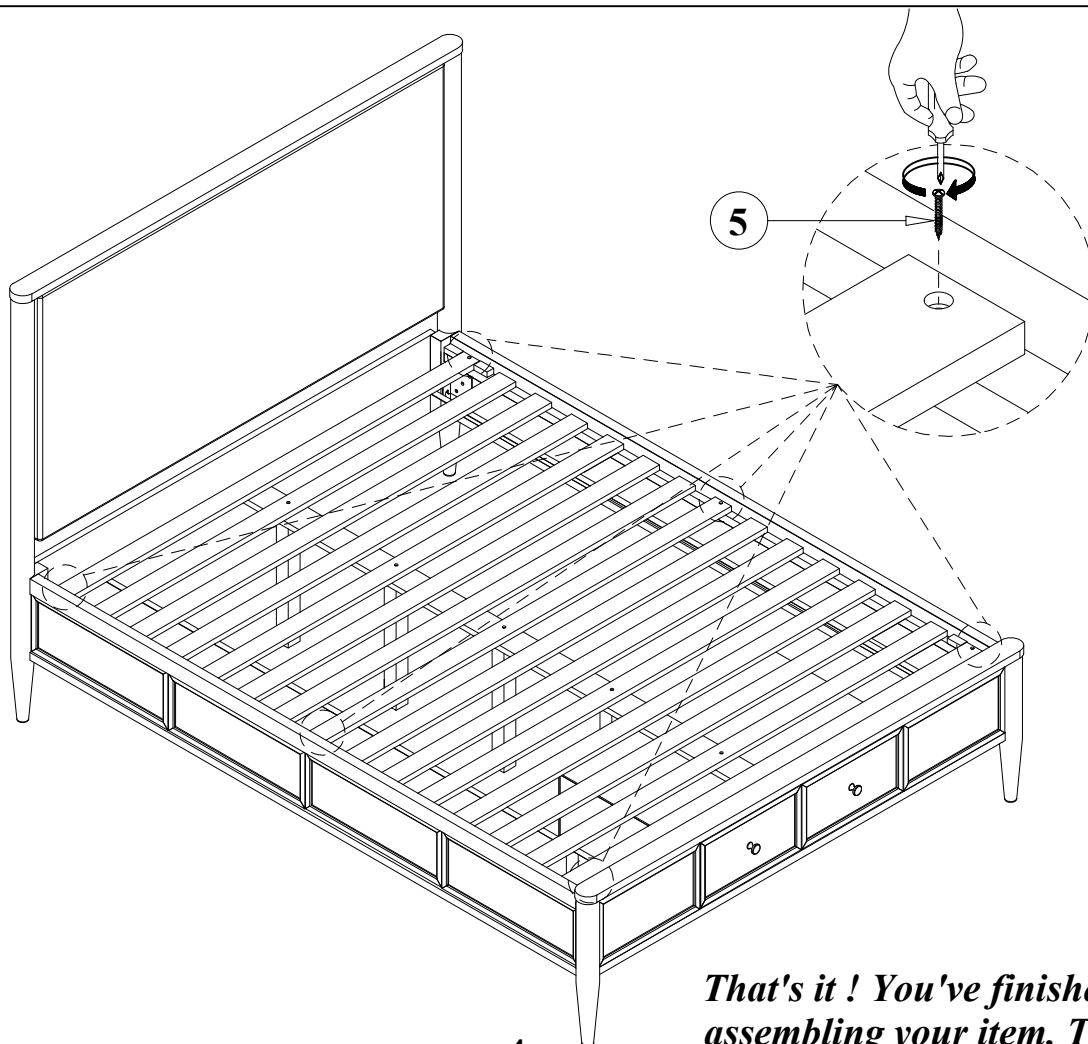

That's it ! You've finished assembling your item. Thank you!