



LIVING SPACES

ASSEMBLY INSTRUCTIONS

AUSTEN QUEEN UPH BED W/ SIDE STORAGE

SKU:318023/318017/318056

AUSTEN QUEEN PANEL BED W/ SIDE STORAGE



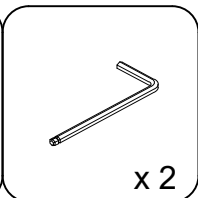
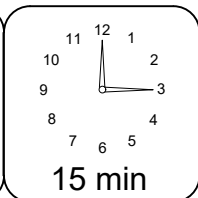
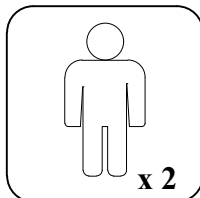
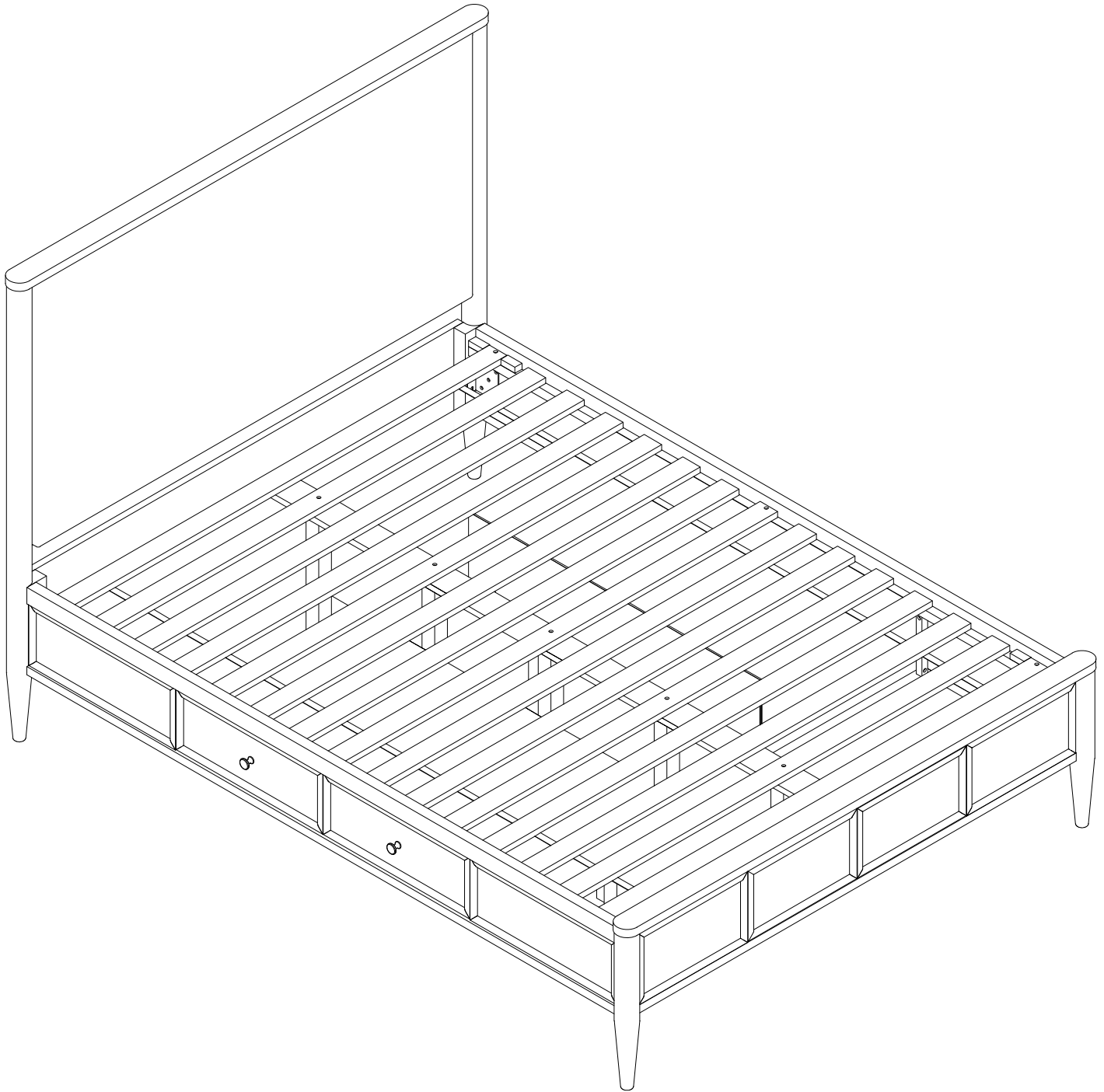

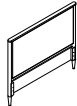
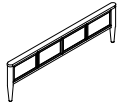
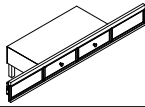
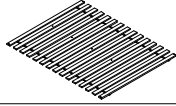
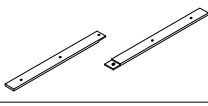
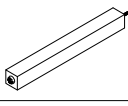
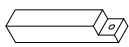

SKU:337936/318017/318056

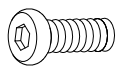

1

PART	SKU#	IMAGE	DESCRIPTION	QTY
(A)	318023/337936		Head Board	1
(B)	318017		Foot Board	1
(C)	318056		Storage Side Rail	2
(D)	318017		Slat	1 set
(E)	318017		Middle Support Bar	2
(F)	318017		Support With Leveler	5
(G)	318056		Side Rail back leg	4

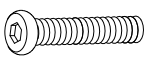
Hardware List

PART	SKU#	IMAGE	DESCRIPTION	QTY
(1)	318056		Bolts 5/16" *25mm	8
(2)	318056		Spring Washer 5/16" Dia	8
(3)	318056		Flat Washer 5/16" * Dia	8
(4)	318056		Allen key	2
(5)	318017		Screw #8* 30mm	6
(6)	318056		Bolts 1/4" *38mm	4
(7)	318056		Spring Washer 1/4"*11mm	4
(8)	318056		Flat Washer 1/4" *19mm	4

THE HARDWARE IS LOCATED IN THE PACKING ITEM

MUST: TIGHTEN SCREWS PERIODIACLLY. WITH USE SCREW MAY ENCOME LOOSE CHECK TIGHTNESS OF ALL SCREWS EVERY 6-8 WEEKS.

CLEANING INSTRUCTIONS:

After assembly, clean and polish the completed parts if necessary with soft cloth and industrial recognized furniture polish.

STEP 1

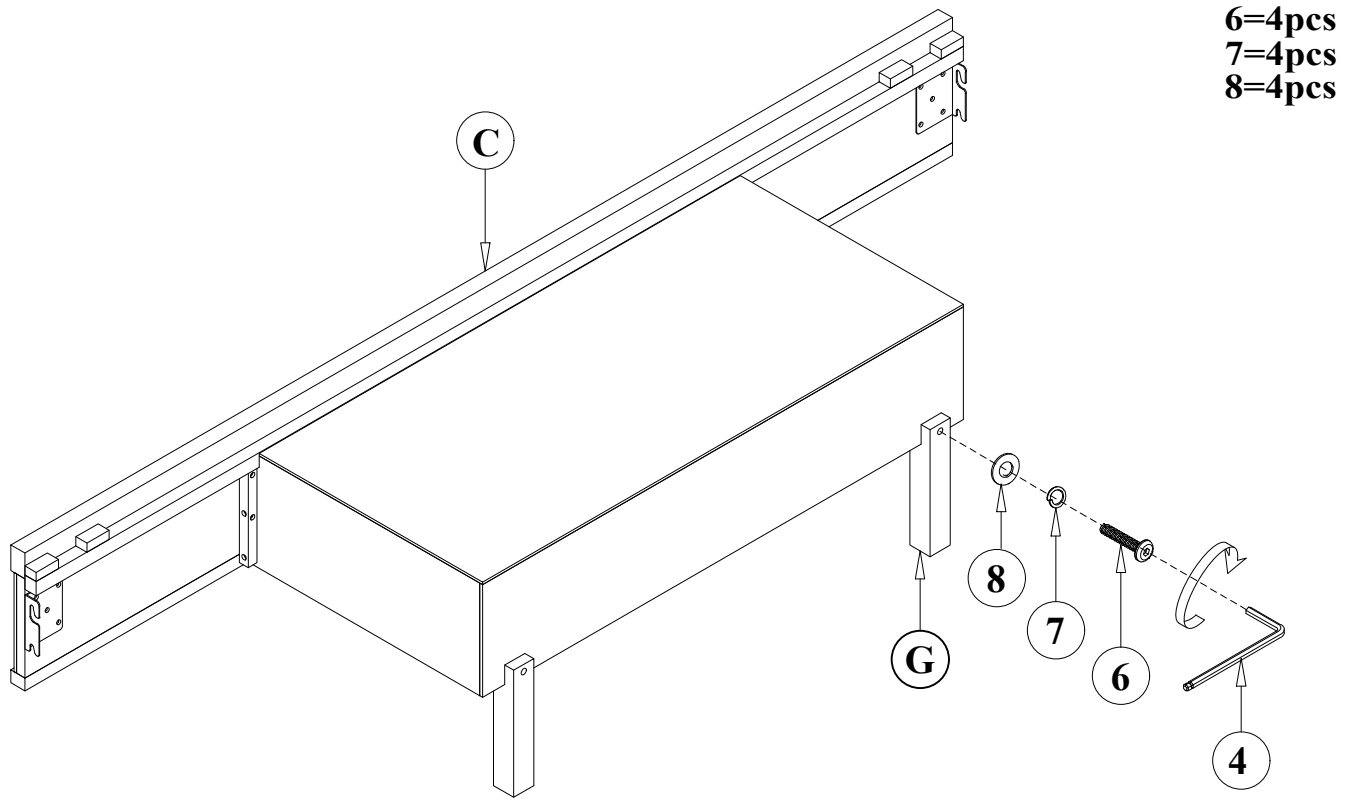

STEP 2

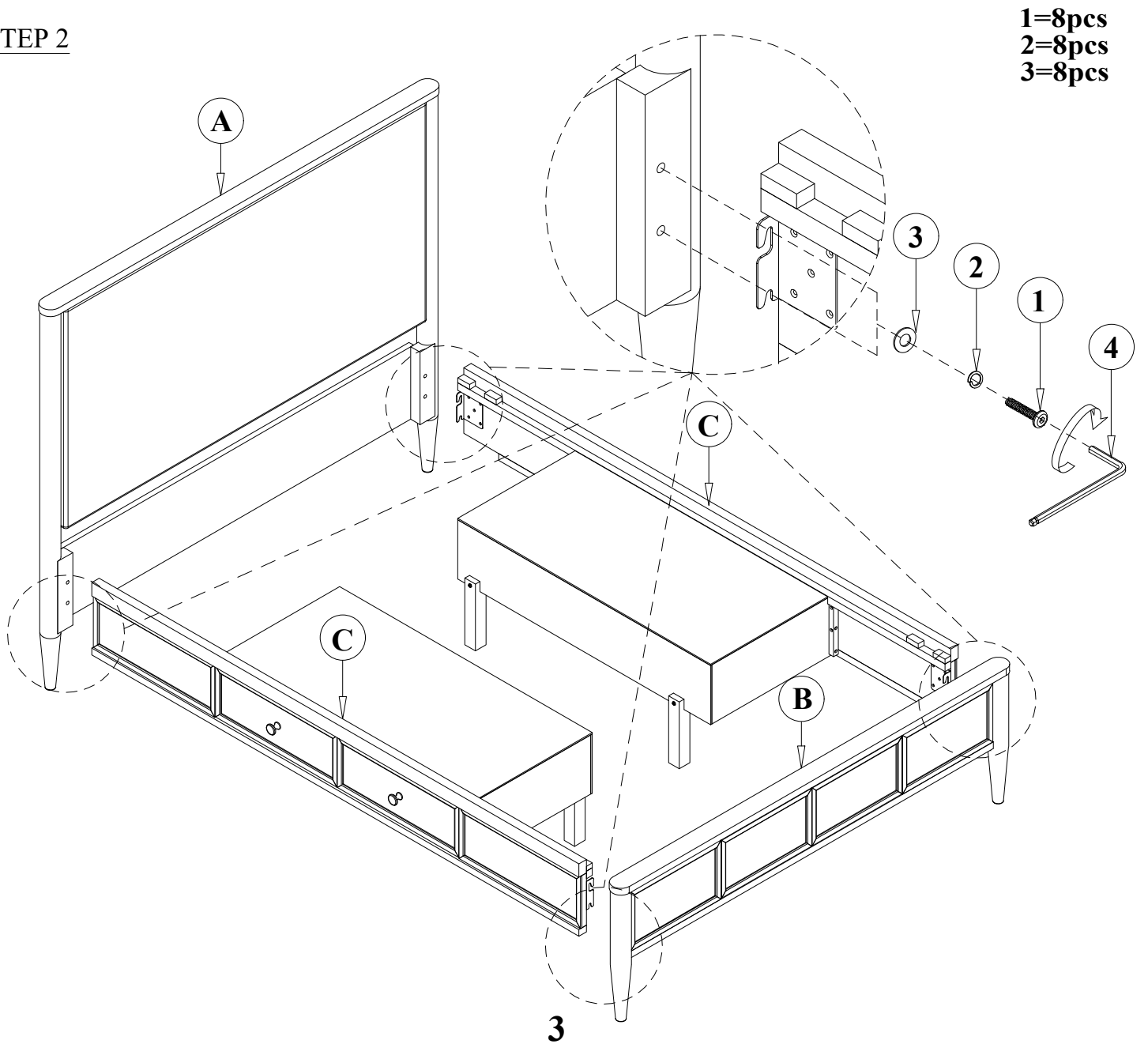

STEP 3

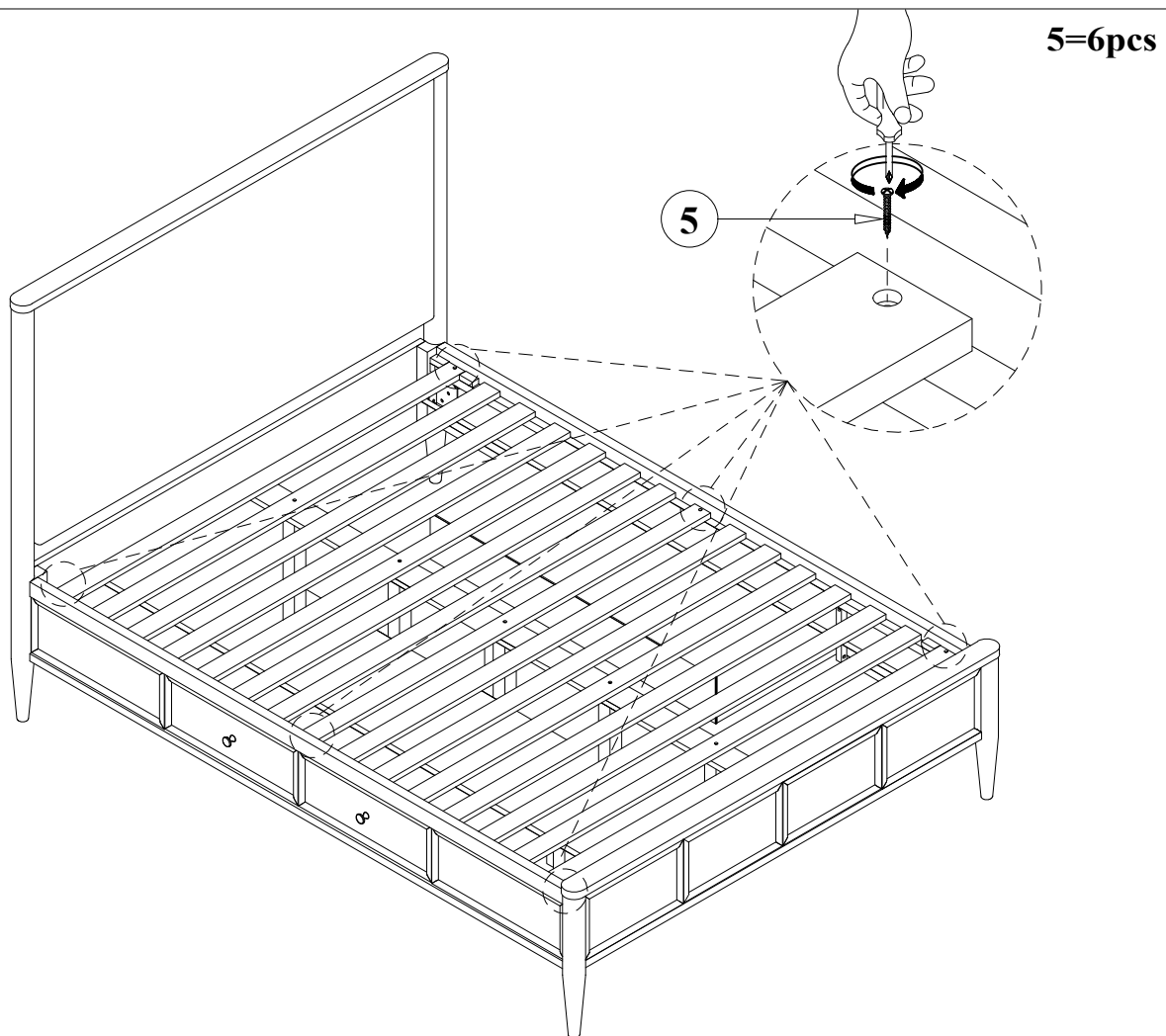
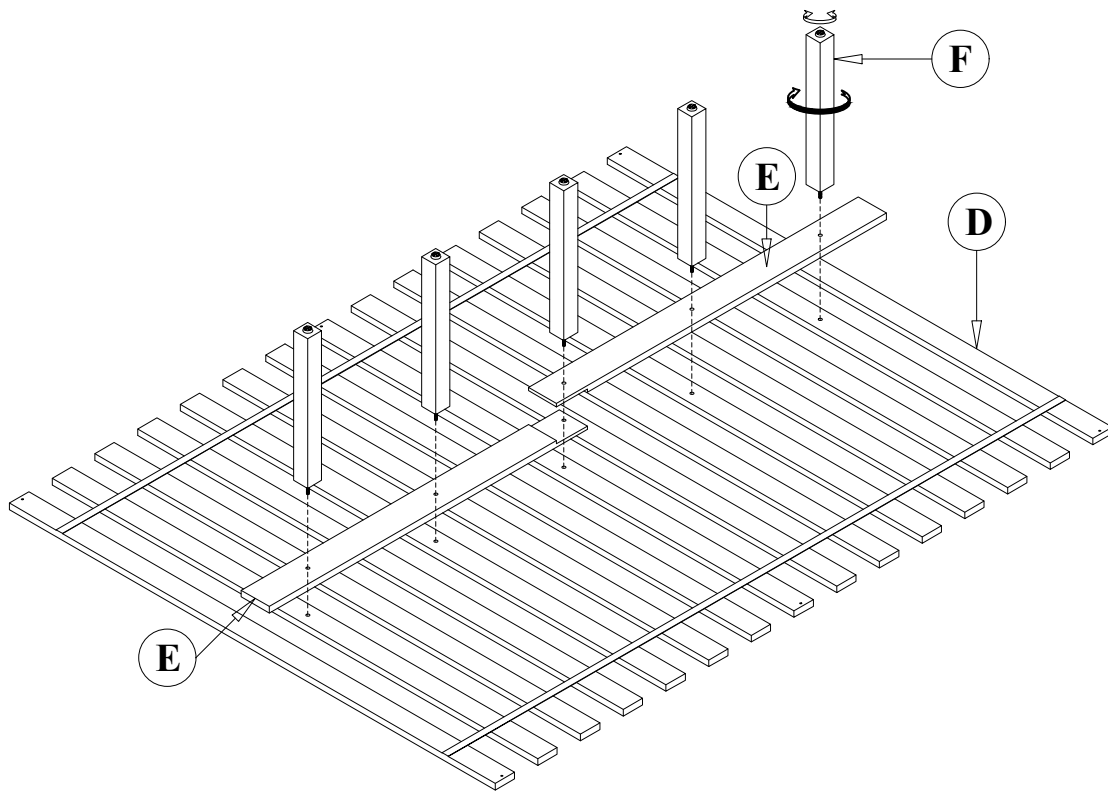

That's it ! You've finished assembling your item. Thank you!