









ASSEMBLY INSTRUCTIONS

ITEM NO : B8270 / B8280 - 2 NIGHT STAND

BOX OF NIGHT STAND

ITEM	DRAWING	DESCRIPTION	QTY
A		NIGHT STAND	1
B		FRONT LEG (WITH "F/L" LABEL)	1
C		FRONT LEG (WITH "F/R" LABEL)	1
D		BACK LEG (WITH "B/L" LABEL)	1
E		BACK LEG (WITH "B/R" LABEL)	1

HARDWARE LIST

ITEM	DRAWING	DESCRIPTION	QTY
1		ALLEN WRENCH (M4)	1
2		CONNECTION BOLT (M6 x 60mm) W/WASHER & SPRING WASHER	4
3		Assembly Tool Not Included	1



**COMPLETED NIGHT STAND
ASSEMBLY**

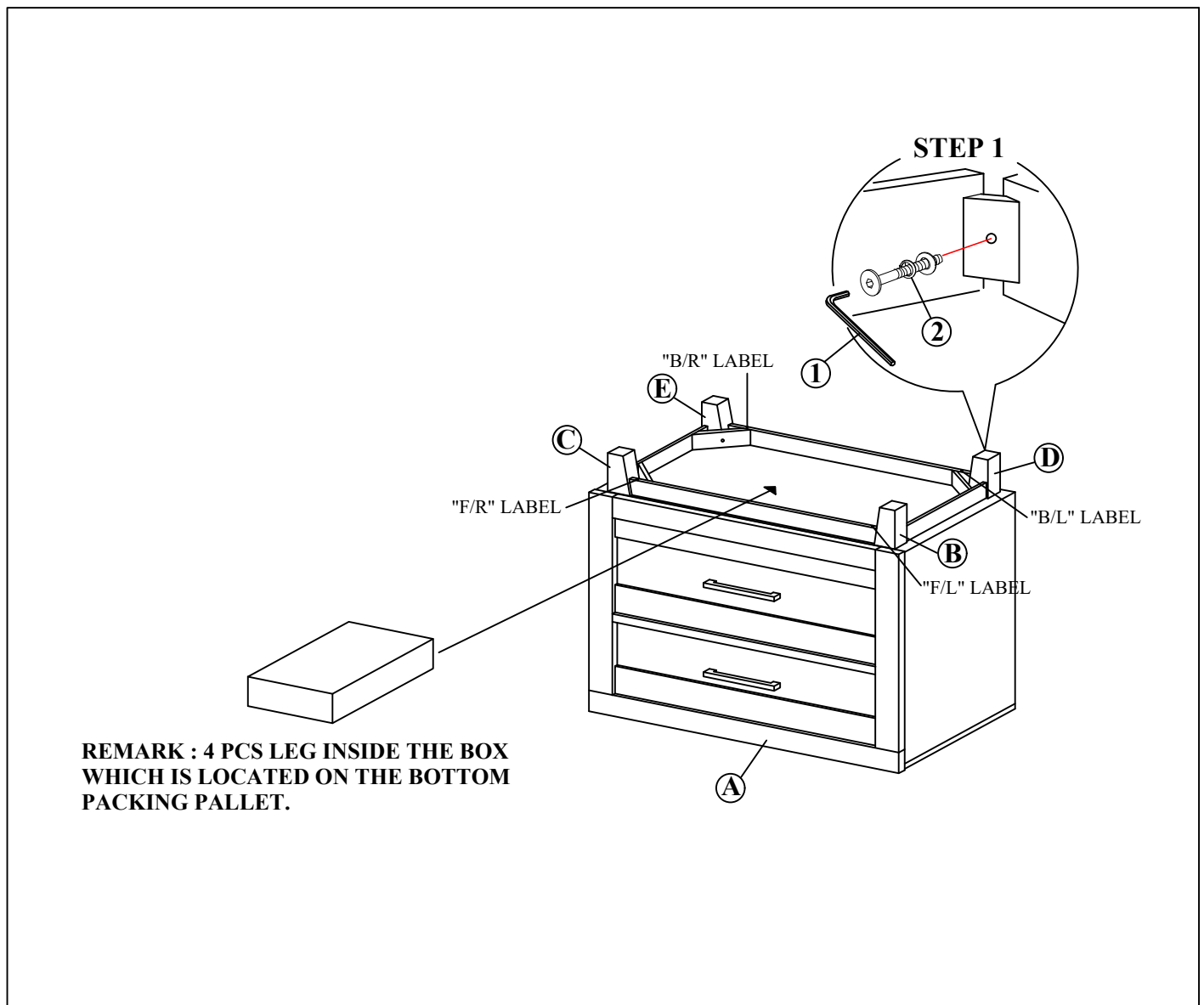

**REMARK : 4 PCS LEG INSIDE THE BOX
WHICH IS LOCATED ON THE BOTTOM
PACKING PALLET.**

THE HARDWARE IS LOCATED IN THE PACKING ITEMS

**NOTE : MUST TIGHTEN SCREWS PERIODICALLY. WITH USE SCREW MAY BECOME LOOSE.
CHECK TIGHTNESS OF ALL SCREW EVERY 6-8 WEEKS.**

CLEANING INSTRUCTION

After assembly, clean & polish the completed parts if necessary with soft cloth and industrial recognized furniture polish

MADE IN MALAYSIA