









ASSEMBLY INSTRUCTIONS

ITEM NO : B8270 / B8280 - 1 DRESSER

BOX OF DRESSER

ITEM	DRAWING	DESCRIPTION	QTY
A		DRESSER	1
B		FRONT LEG (WITH "F/L" LABEL)	1
C		FRONT LEG (WITH "F/R" LABEL)	1
D		BACK LEG (WITH "B/L" LABEL)	1
E		BACK LEG (WITH "B/R" LABEL)	1
F		SUPPORT LEG (Packed underneath bottom panel)	1

HARDWARE LIST

ITEM	DRAWING	DESCRIPTION	QTY
1		ALLEN WRENCH (M4)	1
2		CONNECTION BOLT (M6 x 60mm) W/WASHER & SPRING WASHER	4
3		Assembly Tool Not Included	1



COMPLETED DRESSER ASSEMBLY

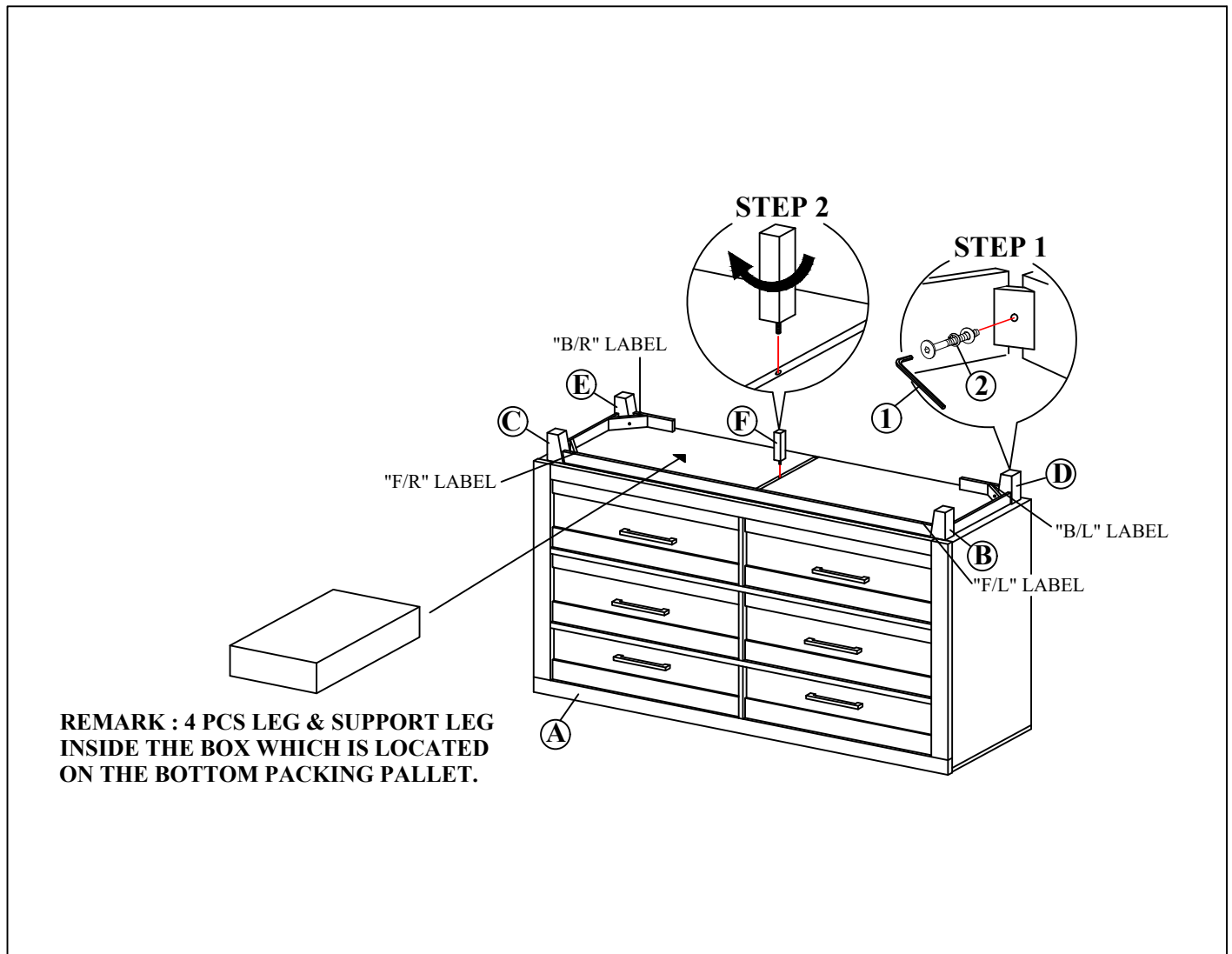

**REMARK : 4 PCS LEG & SUPPORT LEG
INSIDE THE BOX WHICH IS LOCATED
ON THE BOTTOM PACKING PALLET.**

THE HARDWARE IS LOCATED IN THE PACKING ITEMS
THE ANTI TIPPING HARDWARE IS LOCATED IN THE RIGHT SIDE DRAWER FRONT OF DRESSER

NOTE : MUST TIGHTEN SCREWS PERIODICALLY. WITH USE SCREW MAY BECOME LOOSE.
CHECK TIGHTNESS OF ALL SCREW EVERY 6-8 WEEKS.

CLEANING INSTRUCTION





After assembly, clean & polish the completed parts if necessary with soft cloth and industrial recognized furniture polish

MADE IN MALAYSIA

PARTS IDENTIFICATION

A		DRESSER	1 PC
---	---	---------	------

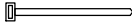
HARDWARE IDENTIFICATION

1		SHORT SCREW	1 PC
2		LONG SCREW	1 PC
3		CABLE TIE	1 PC
4		L BRACKET	2 PCS

This tip restraint must be attached to a wall stud using long screw enclosed.

STEP 1

Attach a bracket securely to the back top rail of the dresser using short screw provided, through the smaller hole.

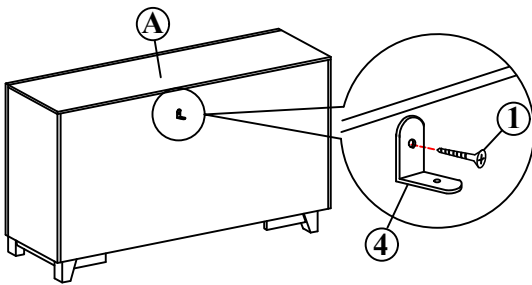

STEP 2

Locate the other bracket on the wall over a wall stud and two inches below the mounting bracket secured to the back of dresser. Attached to the wall stud using the long screw provided, through the smaller hole.

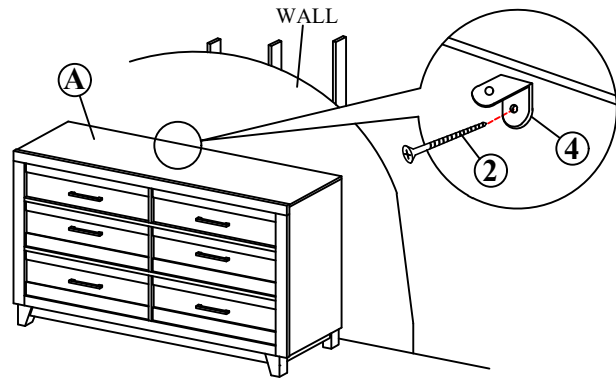

STEP 3

Place the dresser into position so both mounting brackets are vertically in line. Lace the end of the restraint strap through the large hole in each mounting bracket. Bring both ends together and slide the flat end through the locking end and draw it through until all slack is removed. Confirm that the strap is securely laced and locked.

