



## ASSEMBLY INSTRUCTIONS

ITEM 305-S903-632/533/401

### FULL PANEL BED



Thank you for purchasing this quality product. Be sure to check all packing material carefully for small hardware which may have come loose inside the carton during shipment. Identify and count all hardware and compare with the hardware list below.

When placing furniture on non-carpeted flooring, HMI recommends the use of floor protection such as an area rug or furniture pads. Area rugs and padding not included with purchase.

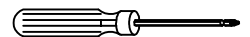
**TOOL REQUIRED (NOT PROVIDED):  
PHILLIPS SCREW DRIVER**

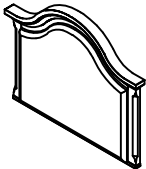
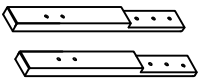
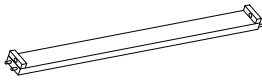
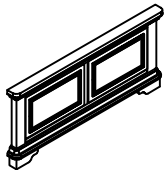

#### PARTS LIST

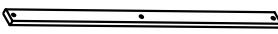
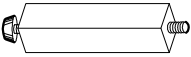
NO.	Description	Sketch	Q.ty
1	Uph Head Board		1
2	Headboard Legs (Left/Right)		2
3	Safety Rail		1
4	Panel Footboard		1
5	Side Rails		2
6	Slats		5
7	Slat Support Leg		5

#### HARDWARE LIST

NO.	Description	Sketch	Q.ty
A	Allen Bolt Ø5/16x 1-3/4"		8
B	Spring Washer Ø5/16 x Ø13		8
C	Flat Washer Ø5/16 x Ø19		8
D	Allen Wrench (4mm)		1
E	Wood Screw M4x35mm		10



Item: 305-S903-632/533/401  
Description: Full Panel Bed

ASSEMBLY INSTRUCTIONS

ITEM 305-S903-632/533/401

FULL PANEL BED

**CAUTION:** Do not attempt to move the bed when fully assembled. This could result in damage to the rails, headboard, or footboard.

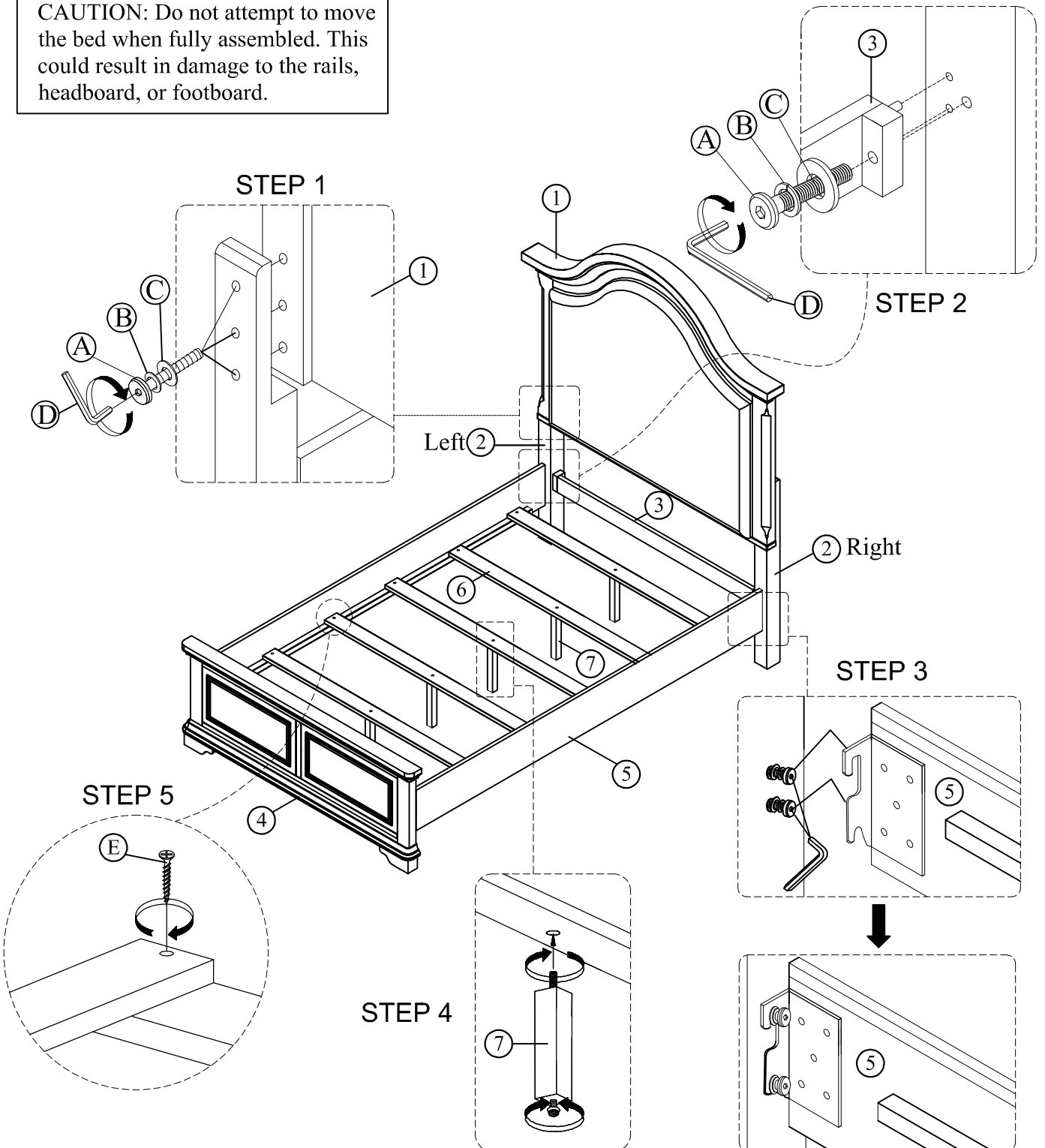

REPLACEMENT PARTS

ITEM 305-S903-632/533/401

FULL PANEL BED

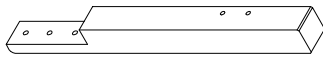

x1 RS903-632-LEGL  
Left Leg

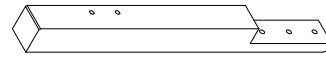

x1 RS903-632-LEGR  
Right Leg

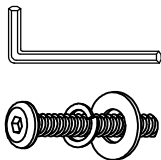

x1 RS903-632-HWKIT  
Hardware kit



x10 RS903-531-SCREW  
Screw

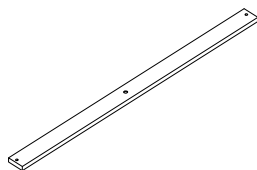

x5 RS903-533- SLAT  
Slat

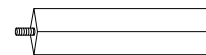

x5 RS903-531- SULEG  
Slat Support Leg