



ASSEMBLY INSTRUCTIONS

ITEM 305-S903-452









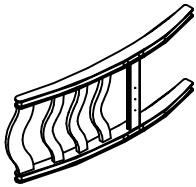

VANITY CHAIR

Thank you for purchasing this quality product. Be sure to check all packing material carefully for small hardware which may have come loose inside the carton during shipment. Identify and count all hardware and compare with the hardware list below.

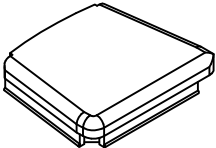
When placing furniture on non-carpeted flooring, HMI recommends the use of floor protection such as an area rug or furniture pads. Area rugs and padding not included with purchase.

**TOOL REQUIRED (NOT PROVIDED):
PHILLIPS SCREW DRIVER**

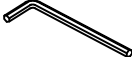

PARTS LIST				HARDWARE LIST			
NO.	Description	Sketch	Q.ty	NO.	Description	Sketch	Q.ty
1	Chair Back		1	A	5/16"*3" Allen Bolt		4
				B	5/16"*1-1/2" Allen Bolt		2
				C	Ø5/16" Hex Nut		4
2	Seat Cushion		1	D	Ø5/16"x Ø13 Spring Washer		10
				E	Ø5/16"x Ø19 Flat Washer		10
3	Front Legs		2	F	Allen Wrench (4mm)		1
				G	13 mm Open Wrench		1



ASSEMBLY INSTRUCTIONS

ITEM 305-S903-452

VANITY CHAIR

STEP 1

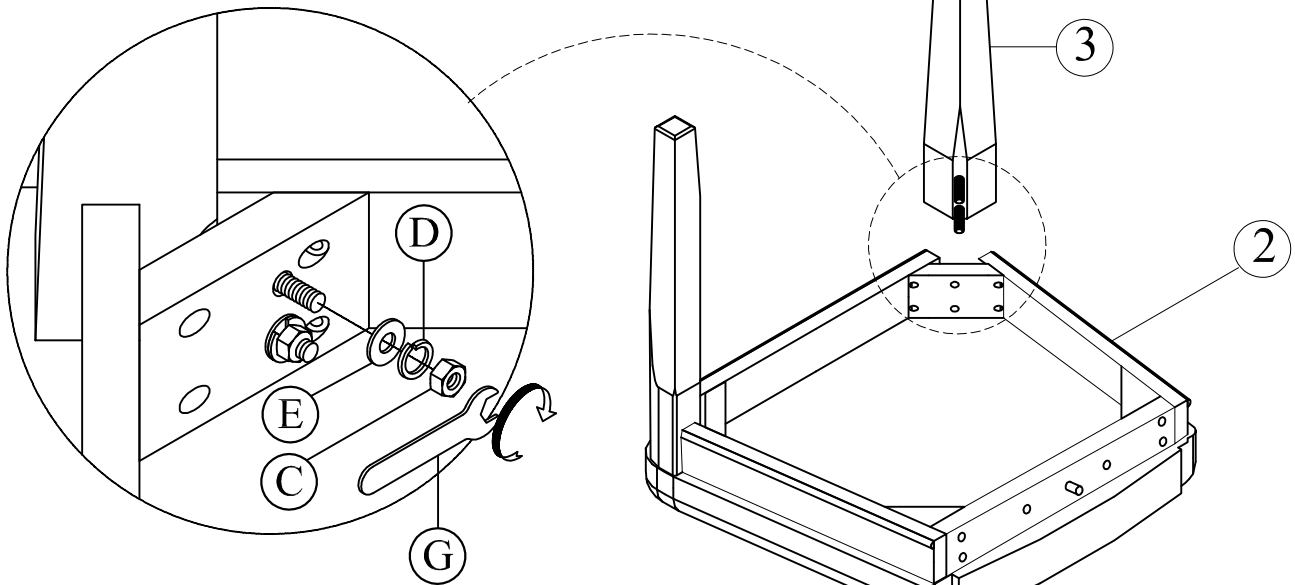

STEP 2

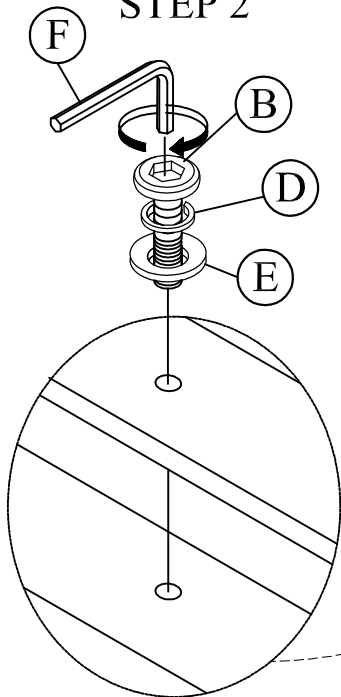

STEP 3

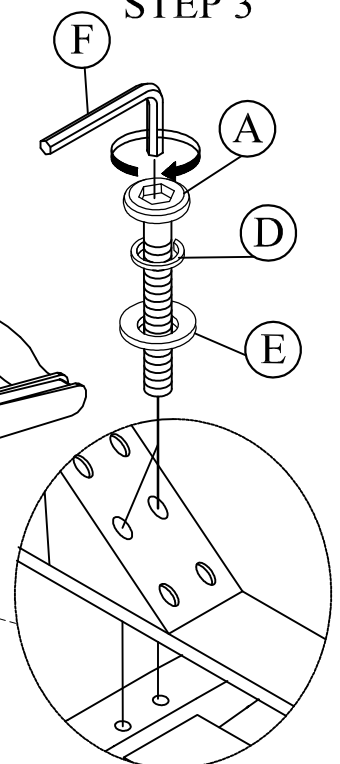



REPLACEMENT PARTS

ITEM 305-S903-452

VANITY CHAIR

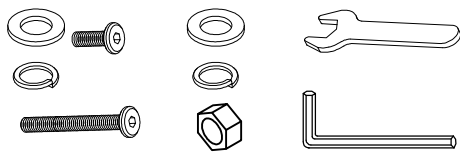

x1 RS903-452-HWKIT
Hardware kit list

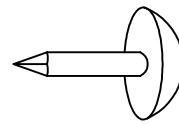

x4 RC-WH-NAIL
White plastic nail



x2 RS903-452-LEGF
Front Legs