



ASSEMBLY INSTRUCTIONS

ITEM 305-S903-410/430

DRESSER MIRROR



Thank you for purchasing this quality product. Be sure to check all packing material carefully for small hardware which may have come loose inside the carton during shipment. Identify and count all hardware and compare with the hardware list below.

When placing furniture on non-carpeted flooring, HMI recommends the use of floor protection such as an area rug or furniture pads. Area rugs and padding not included with purchase.



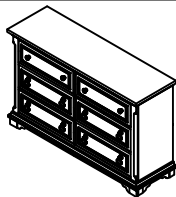
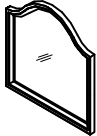

**TOOL REQUIRED (NOT PROVIDED):
PHILLIPS SCREW DRIVER**



PARTS LIST

NO.	Description	Sketch	Q.ty
1	Dresser		1
2	Mirror		1
3	Mirror Support		2

HARDWARE LIST

NO.	Description	Sketch	Q.ty
A	Metal Anti-tipping Kit		1
B	Allen Bolt Ø 1/4" x 1-3/16"		8
C	Spring washer Ø 1/4" x Ø10mm		8
D	Flat washer Ø 1/4" x Ø19mm		8
E	Allen wrench (4mm)		1

ASSEMBLY INSTRUCTIONS

ITEM 305-S903-410/430

DRESSER
MIRROR

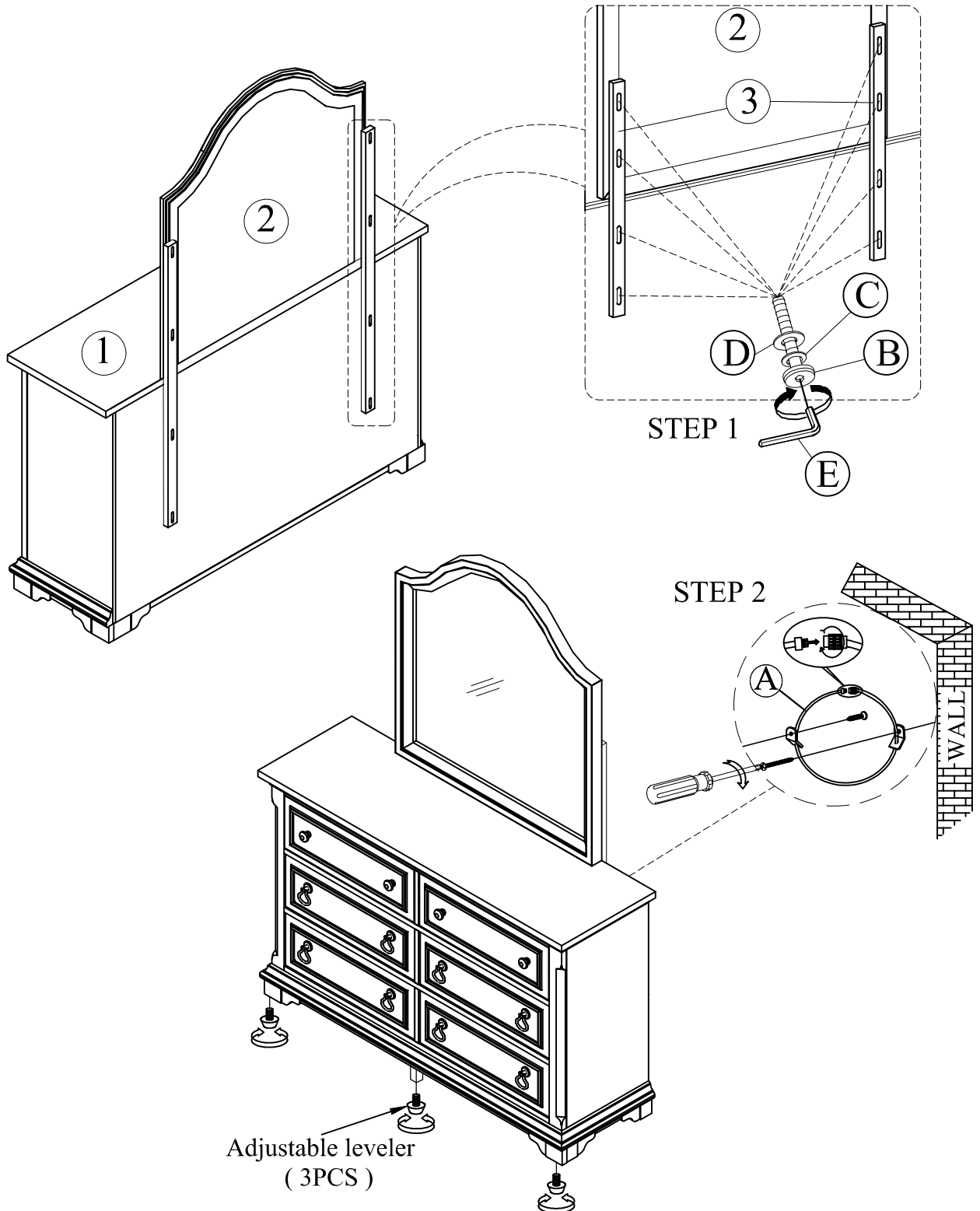

REPLACEMENT PARTS

ITEM 305-S903-410/430
DRESSER
MIRROR

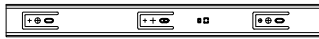

x6 COMGLIDE-10-45
Common Glide 10in-45mm



x4 RS903-410-KNOB
Knob with screw



x8 RS903-410-PULL
Pull with screw

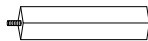

x1 RS903-410-CE
Center support leg

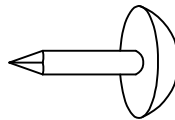

x2 RC-WH-NAIL
White plastic nail

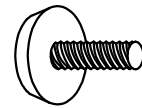

x3 RC-FG-WHITE
White leveler

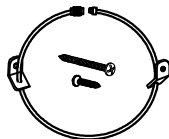

x1 RC-METAL-ANTI-TIP KIT
Metal Anti-tipping kit

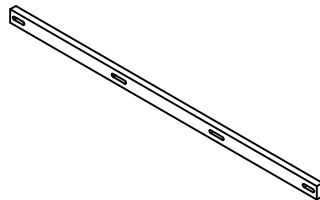

x2 RS903-430-MISU
Mirror Support

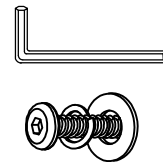

x1 RS903-430-HWKIT
Hardware kit