











LIVING SPACES

| | | | |
|---|---------------|---|-----|
| 1 | PD5333-62CB |  | X1 |
| 2 | PD5333-62SE |  | X1 |
| 3 | PD5333-62LG |  | X2 |
| A | PD5333-62HD-A |  | X4 |
| | | 1/4" DIAMETER x 3" | |
| B | PD5333-62HD-B |  | X3 |
| | | 1/4" DIAMETER x 1-5/8" | |
| C | PD5333-62HD-C |  | X4 |
| | | 5/16" DIAMETER x 1/2" | |
| D | PD5333-62HD-D |  | X11 |
| | | 5/16" DIAMETER x 1/2" x 1/16" | |
| E | PD5333-62HD-E |  | X11 |
| | | 5/16" DIAMETER x 3/4" x 1/16" | |
| F | PD5333-62HD-F |  | X1 |
| G | PD5333-62HD-G |  | X1 |

LUIS

1

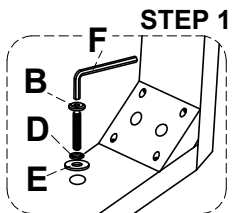

2

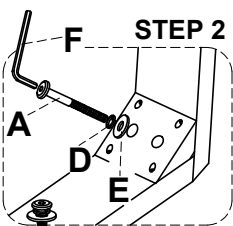

3

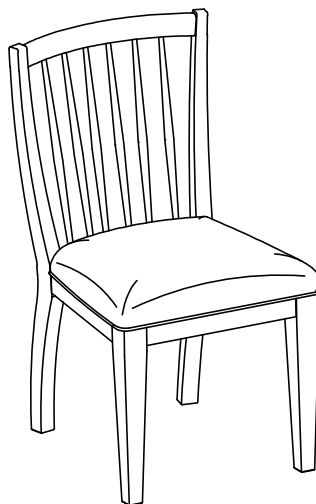
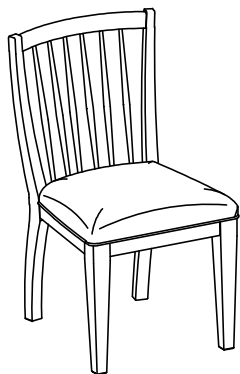
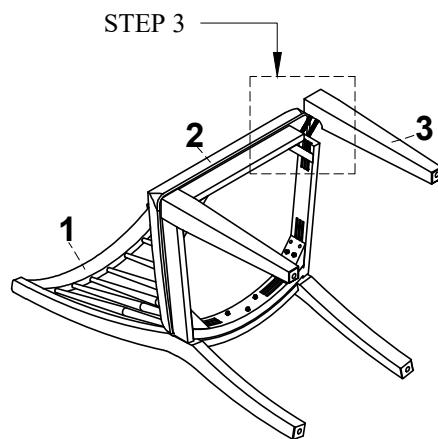
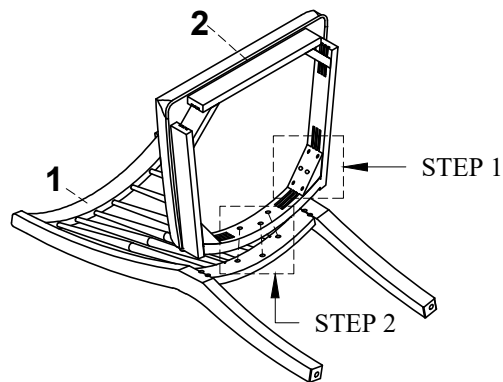
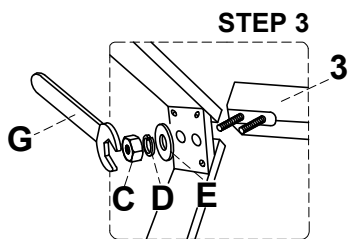

312846/319015/319016
D5333-62 WOOD BACK DINING CHAIR

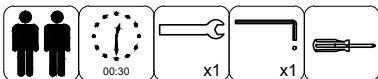

Not provided



WARNING:
ONLY USE THE HAND
TOOLS PROVIDED