









LIVING SPACES

A	1005		x 1
B	2619		x 1
C	5812		x 1
D	7602		x 1
E	7002 Parts F - I		x 1
F	1/4-20 x 1-3/8" Long Allen Head Bolt		x 12
G	M 1/4" Spring Washer		x 12
H	M1/4" x 16 x 2mm Flat Washer		x 12
I	4mm Allen Wrench		x 1

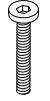

#22469
Pierce Bedroom
1-Drawer Nightstand

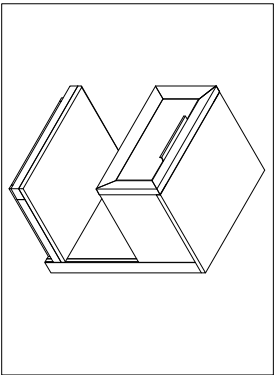

1

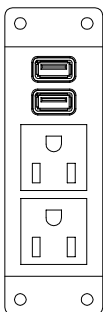
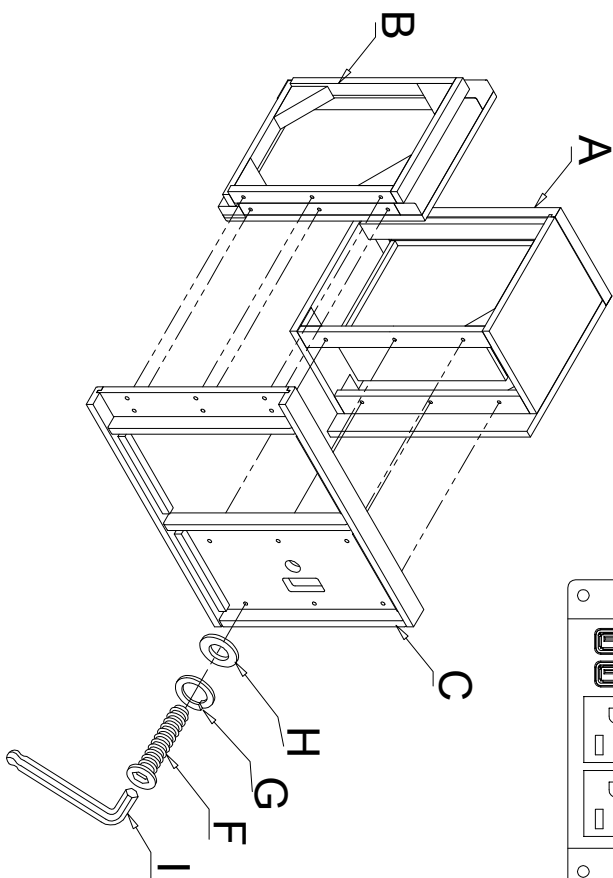

There is a two-outlet power bar with USB ports mounted at the back, which can be used to conveniently supply power to personal electronic devices or other accessories, when plugged into a wall outlet.

- Step 1. To prevent possible scratches and damage, this furniture must be assembled on a soft surface such as a blanket or carpet, or its own packing material. Place the Top Frame (A) on its side and attach the Back Frame (C) and Bottom Frame (B) using the Bolts (F), Spring Washers (G) and Flat Washers (H).
- Step 2. Check and adjust parts fit, if necessary and tighten Bolts using the Allen Wrench (I).
- Step 3. Set the assembled Nightstand upright.

2

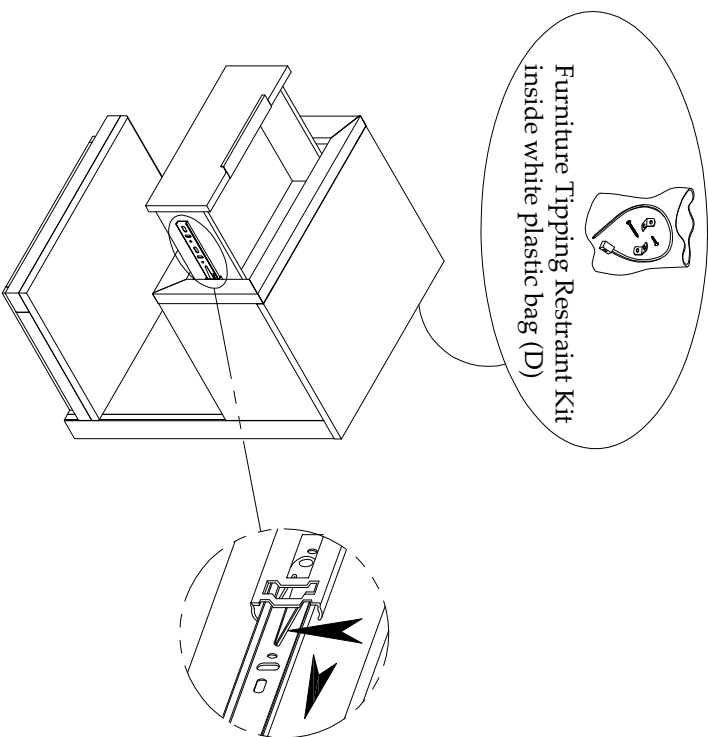

To remove the drawer if it ever becomes necessary:

- Pull the drawer fully open so the black latch is visible in the inside channel of the guides.
- Release the latches by simultaneously pushing one lever up and the other down.
- At the same time, pulling the drawer forward until the slides release.

To reinstall the drawers, carefully align the channels of the guide and push drawer back into Dresser. Open and close drawer fully a couple times to verify proper operation.