



LIVING SPACES

ASSEMBLY INSTRUCTIONS

AUSTEN 3 DRAWER NIGHTSTAND
ITEM NO: B2101-103

SKU:318008

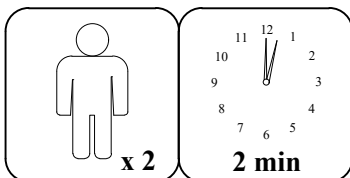
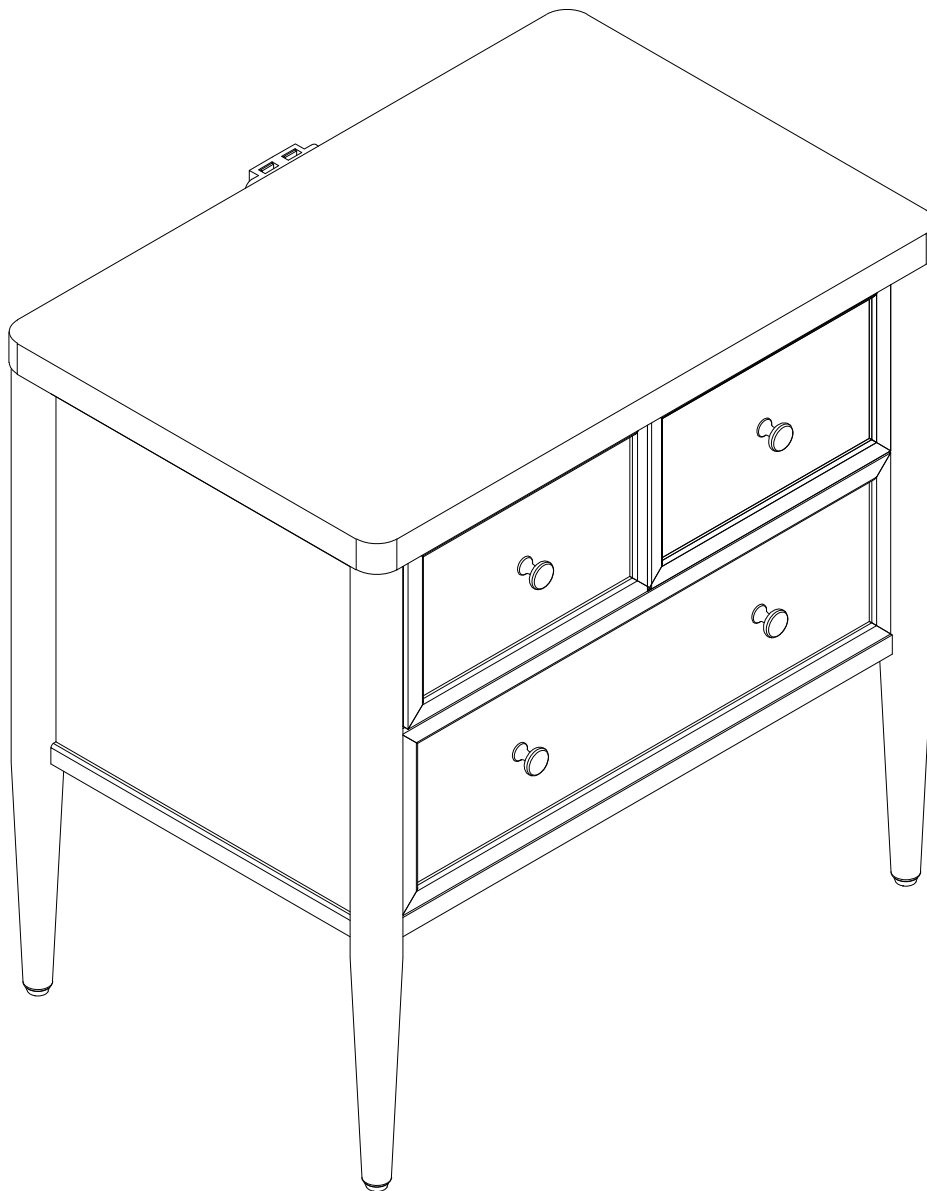



x 2

2 min

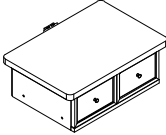
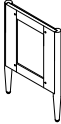
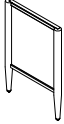
1

PART	SKU#	IMAGE	DESCRIPTION	QTY
(A)	318008		Desk Top	1
(B)	318008		End assembly Right	1
(C)	318008		End assembly Left	1

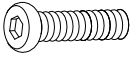
Hardware List

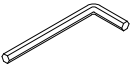
PART	SKU#	IMAGE	DESCRIPTION	QTY
(1)	318008		Bolts 1/4" *35mm	8
(2)	318008		Spring Washer 1/4"*11mm	8
(3)	318008		Flat Washer 1/4"*19mm	8
(4)	318008		Allen key	1

THE HARDWARE IS LOCATED IN THE PACKING ITEM

**MUST: TIGHTEN SCREWS PERIODIACLLY. WITH USE SCREW
MAY ENCOME LOOSE CHECK TIGHTNESS OF ALL SCREWS EVERY 6-8
WEEKS.**

CLEANING INSTRUCTIONS:

**After assembly, clean and polish the completed parts if necessary with
soft cloth and industrial recognized furniture polish.**

STEP 1

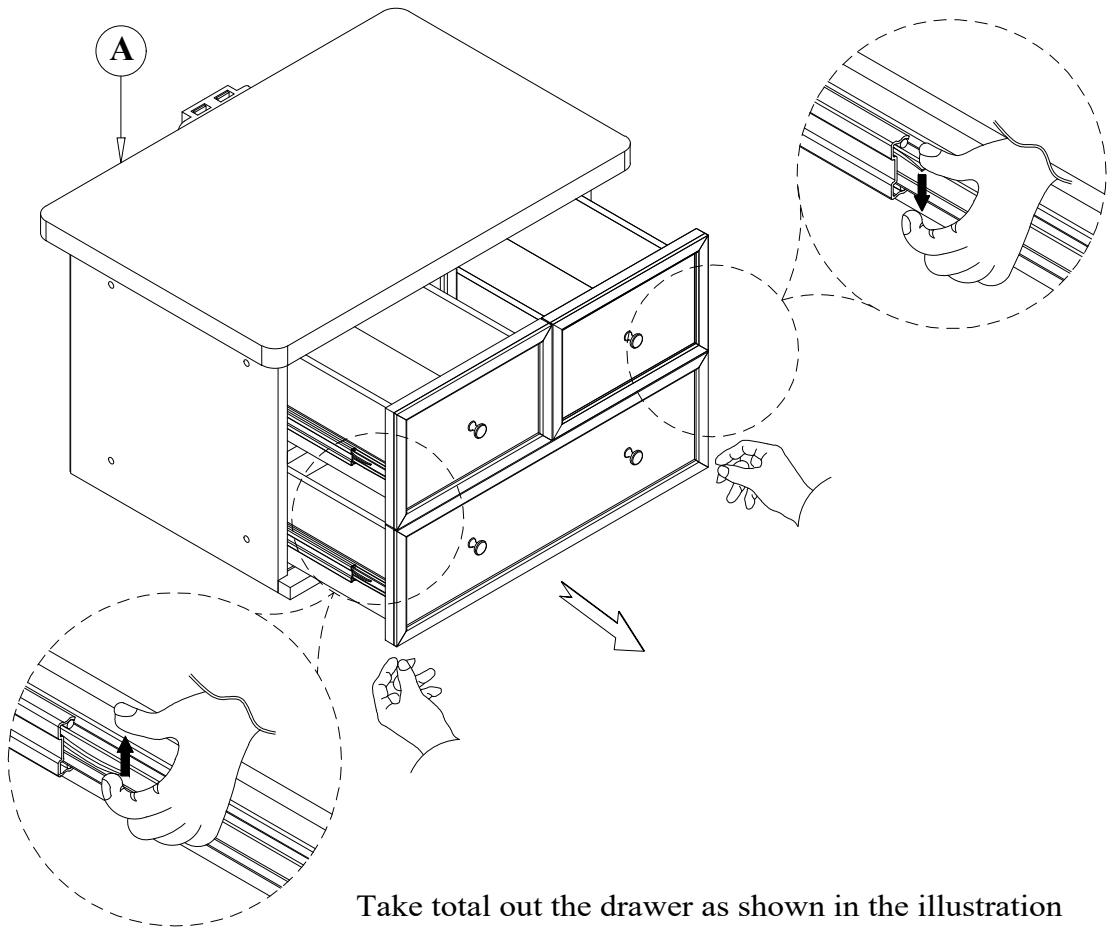

Take total out the drawer as shown in the illustration

STEP 2

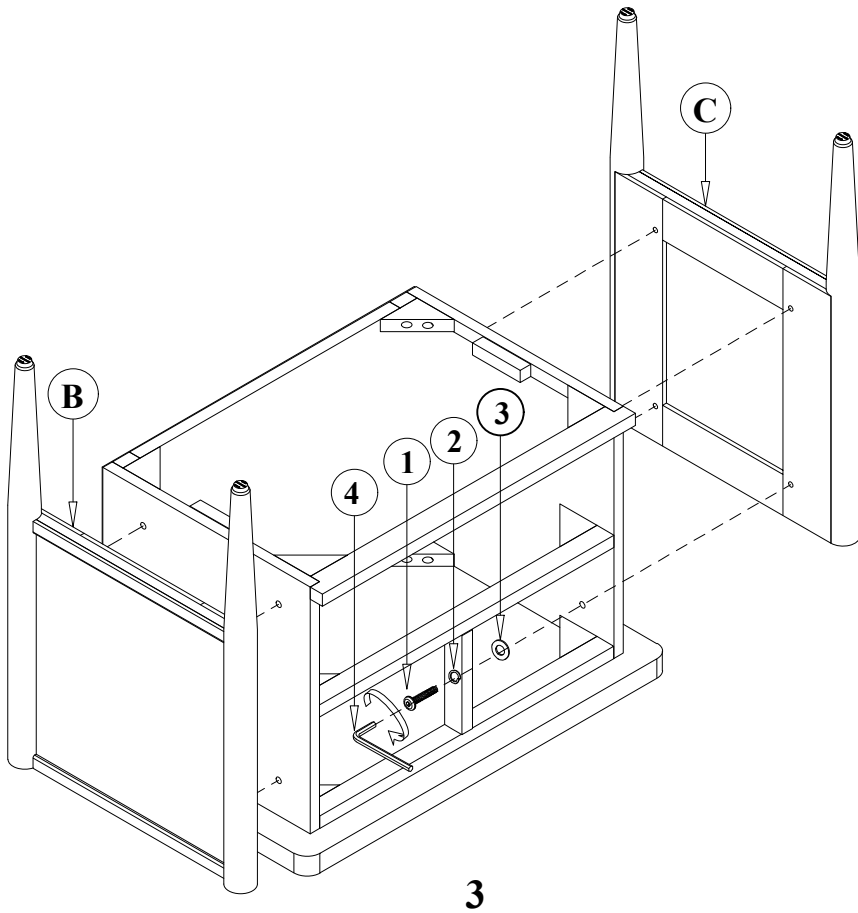

1=8pcs
2=8pcs
3=8pcs

3

STEP 3

Install the drawer back as shown in the illustration.

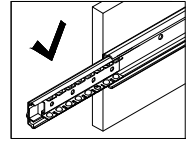
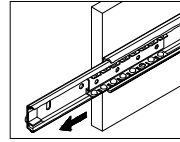
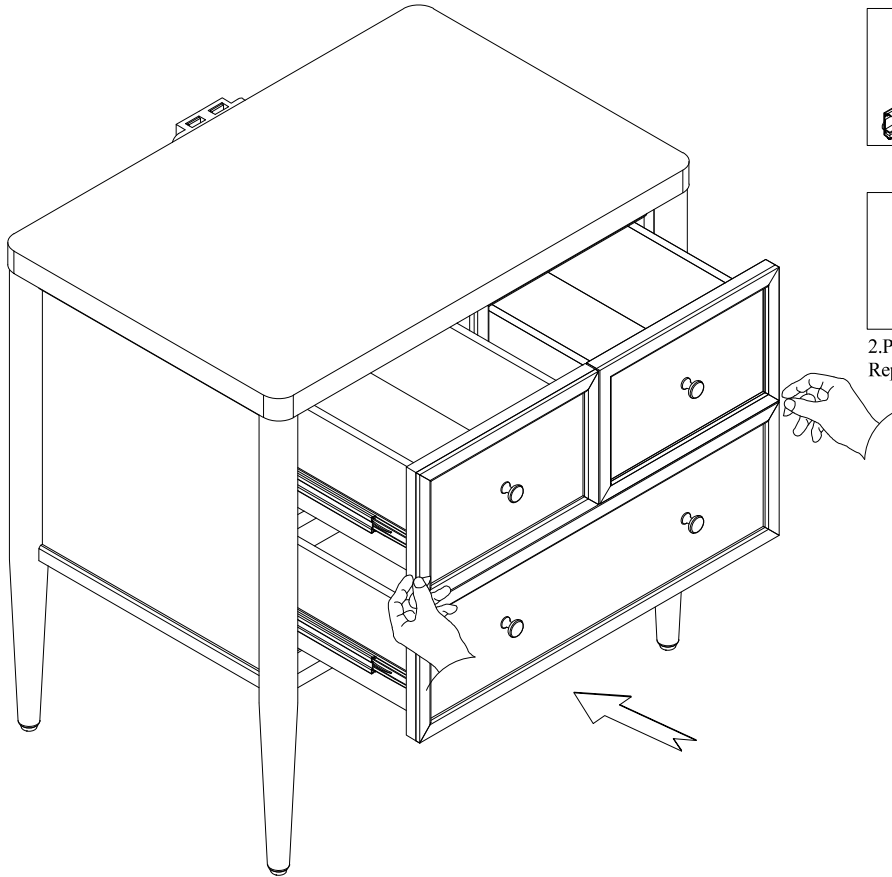

1. Pull out slide. Slide bearings forward

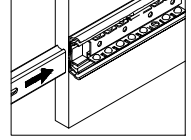
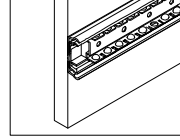

2. Push slide back inside.
Repeat for every slide

3. Insert into slide
slot correctly push
the drawer into the
table body with force

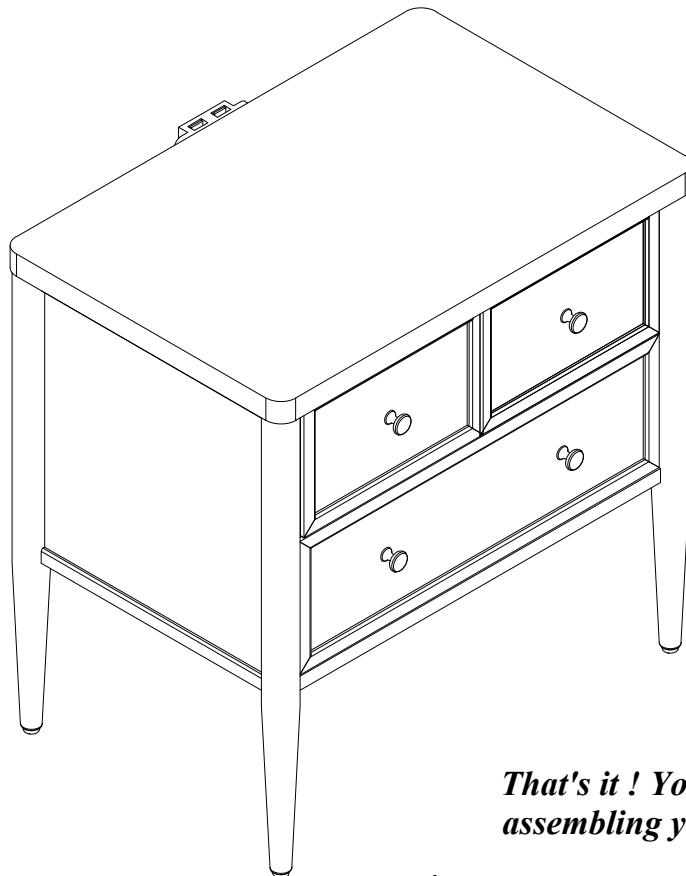

***That's it ! You've finished
assembling your item. Thank you!***