



LIVING SPACES



ASSEMBLY INSTRUCTIONS

AUSTEN 1 DRAWER NIGHTSTAND
ITEM NO: B2101-101

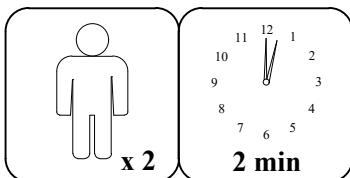
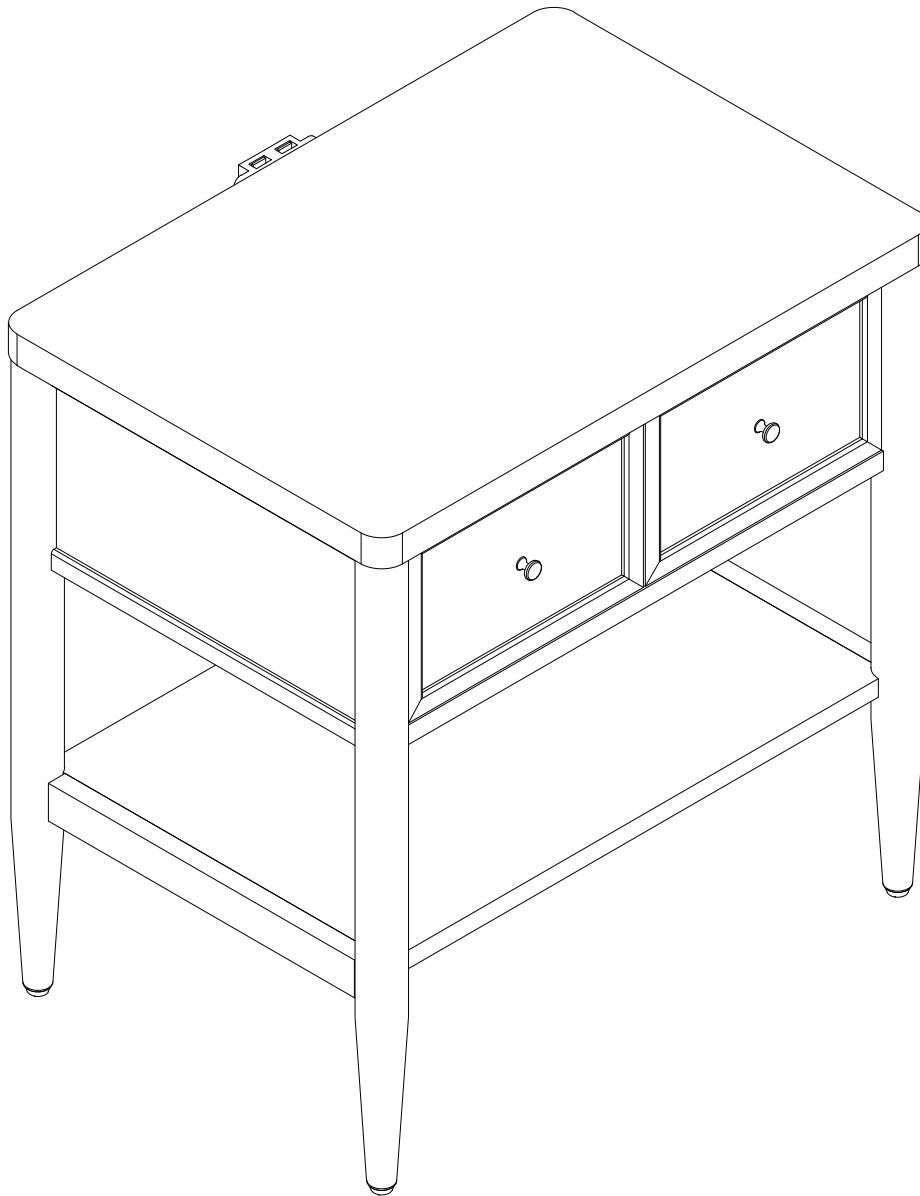

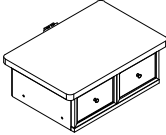
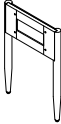

SKU:318007

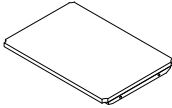

1

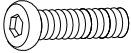
PART	SKU#	IMAGE	DESCRIPTION	QTY
(A)	318007		Desk Top	1
(B)	318007		End assembly Right	1
(C)	318007		End assembly Left	1
(D)	318007		Shelf	1

Hardware List

PART	SKU#	IMAGE	DESCRIPTION	QTY
(1)	318007		Bolts 1/4" *35mm	12
(2)	318007		Spring Washer 1/4"*11mm	12
(3)	318007		Flat Washer 1/4"*19mm	12
(4)	318007		Allen key	1

THE HARDWARE IS LOCATED IN THE PACKING ITEM

**MUST: TIGHTEN SCREWS PERIODICALLY. WITH USE SCREW
MAY ENCOME LOOSE CHECK TIGHTNESS OF ALL SCREWS EVERY 6-8
WEEKS.**

CLEANING INSTRUCTIONS:

**After assembly, clean and polish the completed parts if necessary with
soft cloth and industrial recognized furniture polish.**

STEP 1

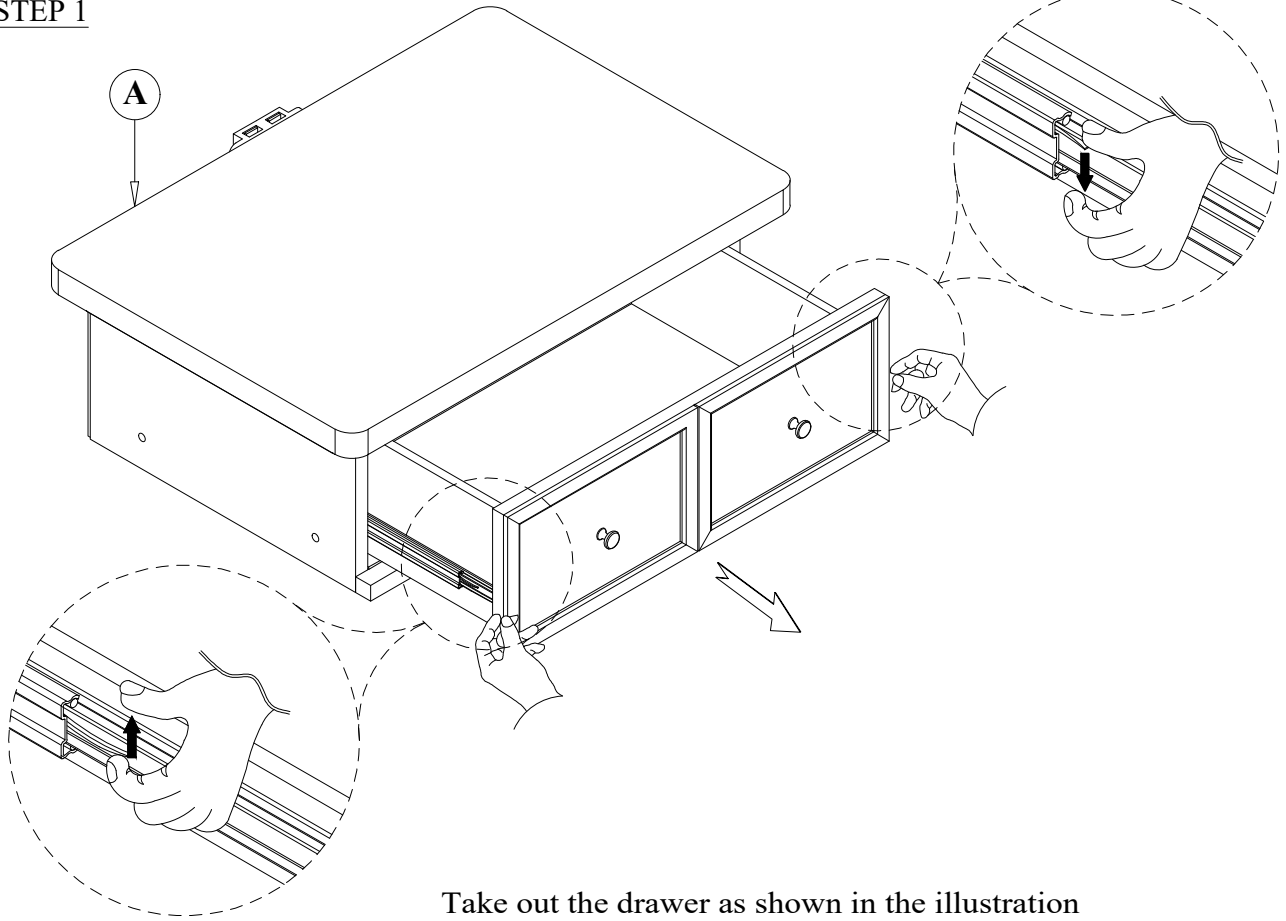

Take out the drawer as shown in the illustration

STEP 2

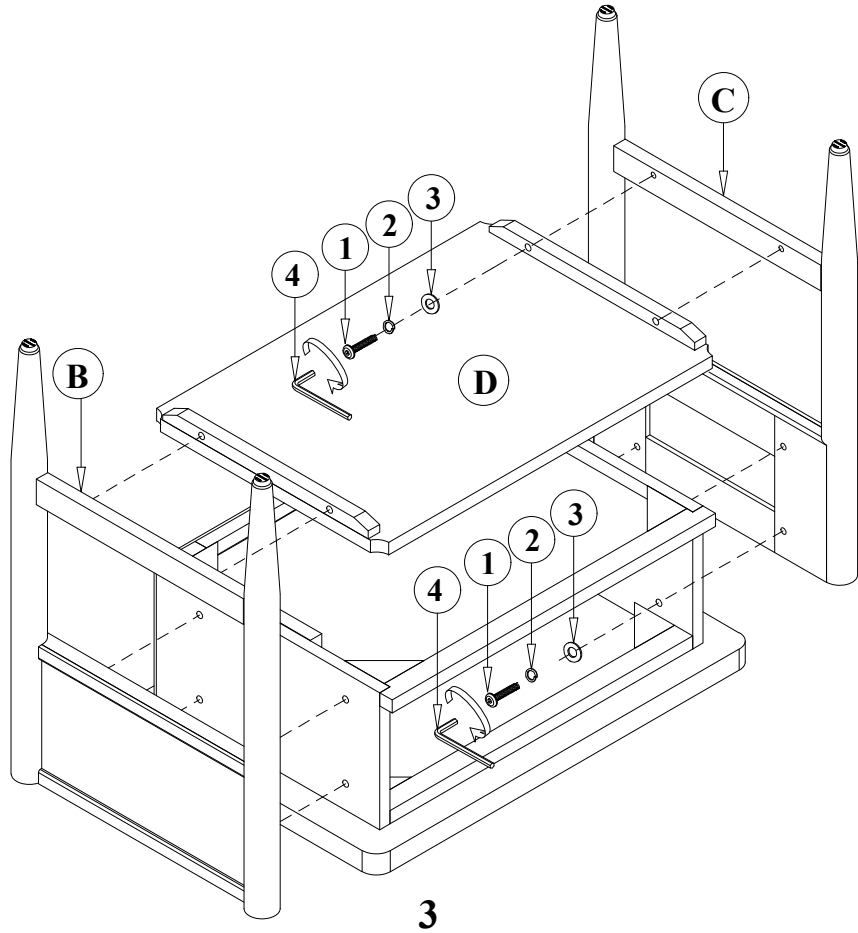

1=12pcs
2=12pcs
3=12pcs

STEP 3

Install the drawer back as shown in the illustration.

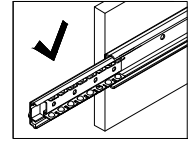
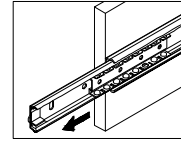
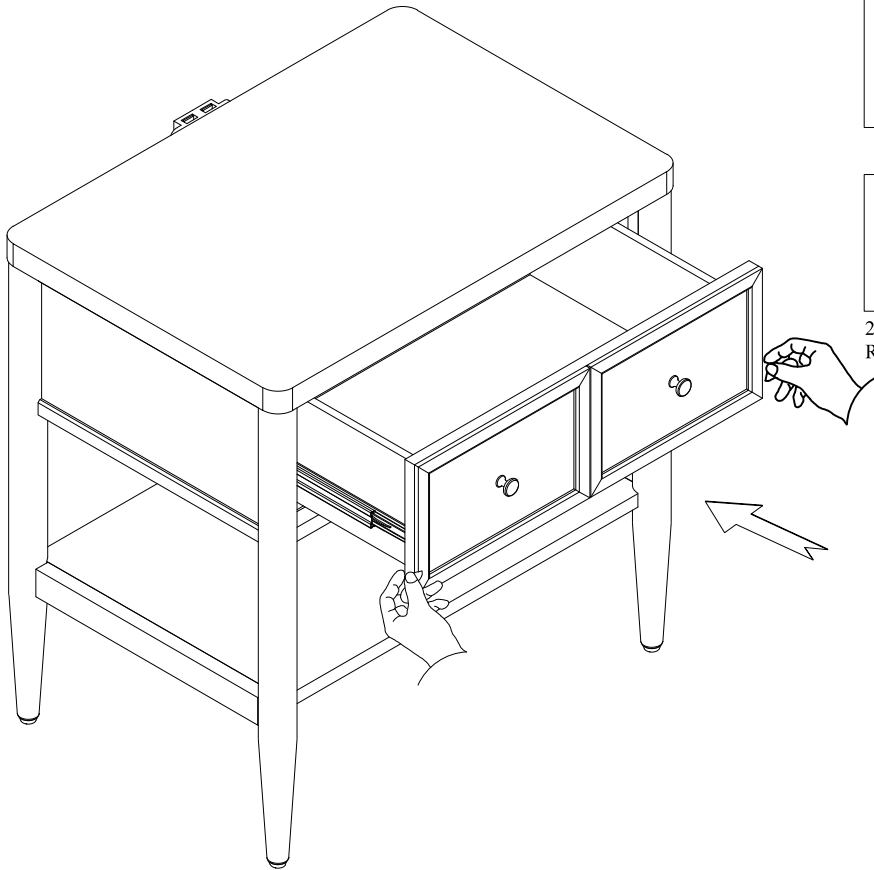

1. Pull out slide. Slide bearings forward

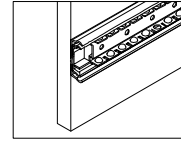

2. Push slide back inside.
Repeat for every slide

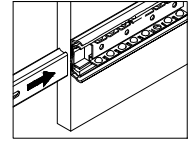

3. Insert into slide slot correctly push the drawer into the table body with force

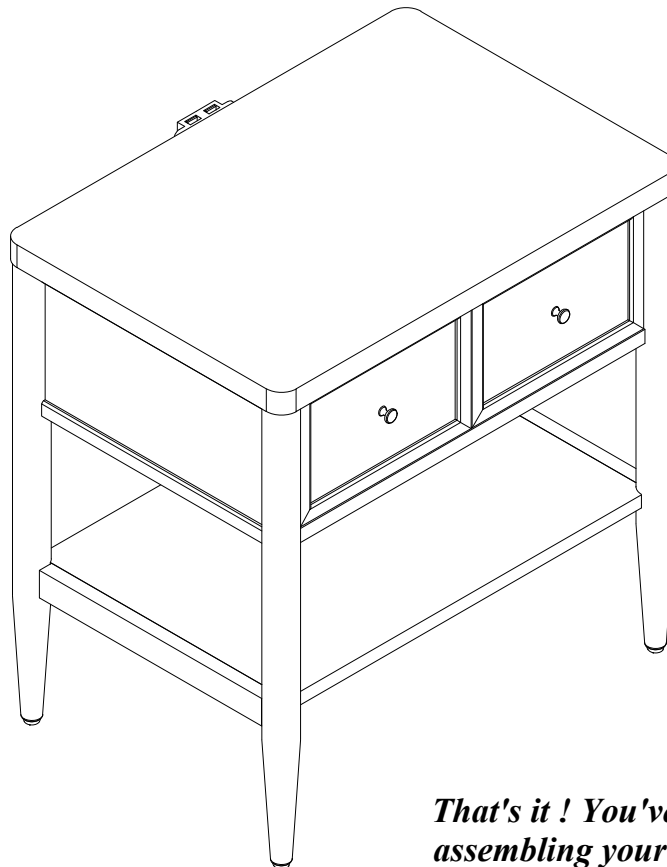

That's it ! You've finished assembling your item. Thank you!