



LIVING SPACES

ASSEMBLY INSTRUCTIONS

AUSTEN QUEEN UPH BED

SKU:318023/318017/318057



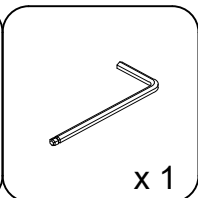
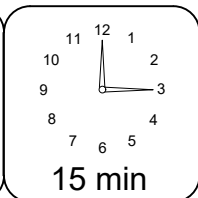
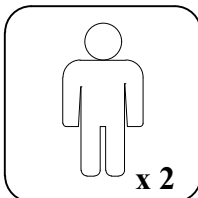
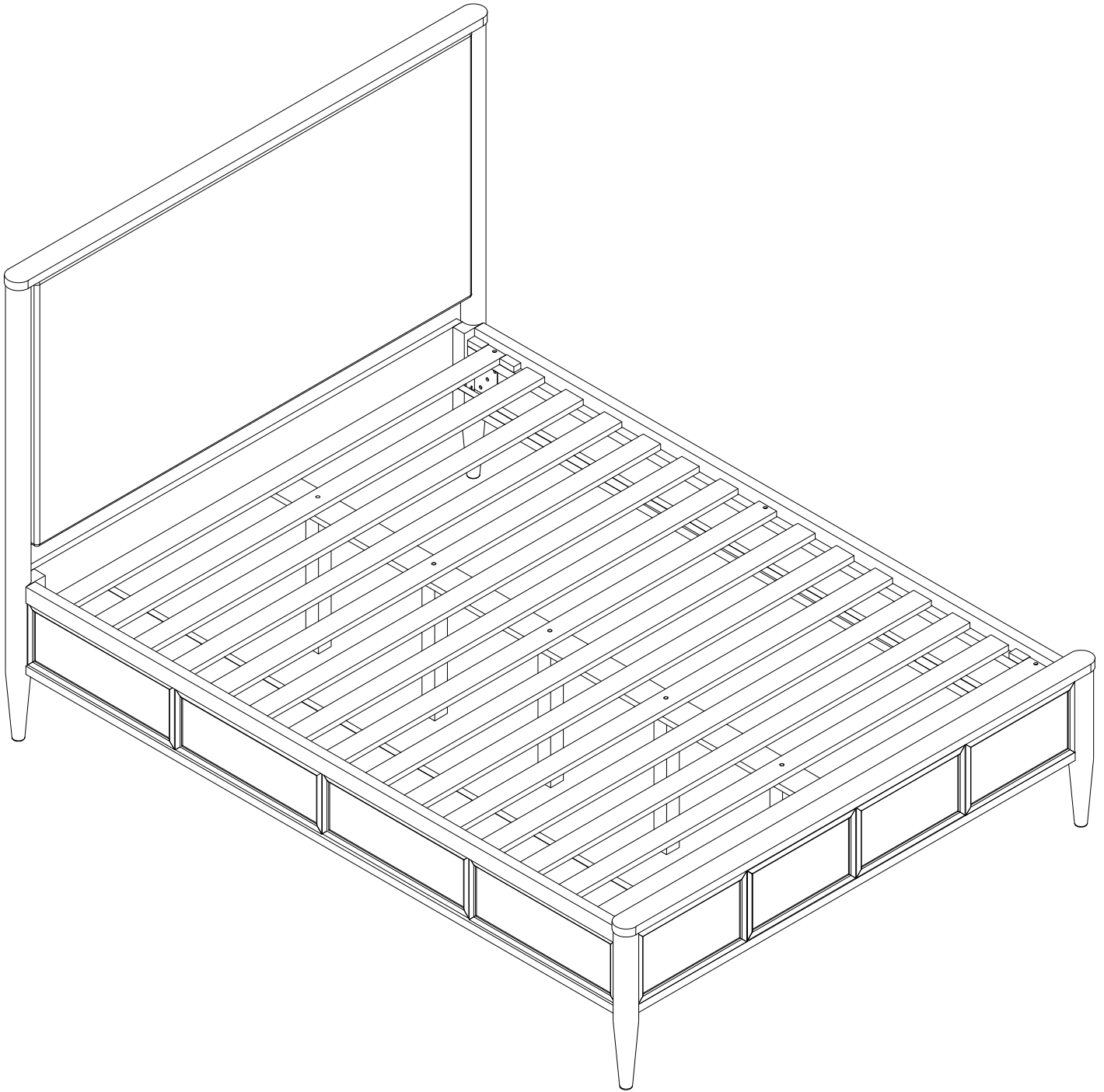

AUSTEN QUEEN PANEL BED

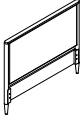
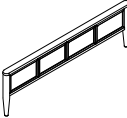
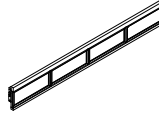
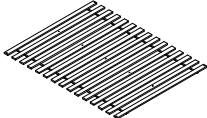
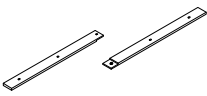
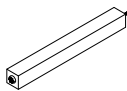
SKU:337936/318017/318057

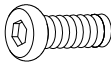

PART	SKU#	IMAGE	DESCRIPTION	QTY
(A)	318023/337936		Head Board	1
(B)	318017		Foot Board	1
(C)	318057		Side Rail	2
(D)	318017		Slat	1 set
(E)	318017		Middle Support Bar	2
(F)	318017		Support With Leveler	5

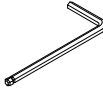
Hardware List

PART	SKU#	IMAGE	DESCRIPTION	QTY
(1)	318057		Bolts 5/16" *25mm	8
(2)	318057		Spring Washer 5/16" Dia	8
(3)	318057		Flat Washer 5/16" * Dia	8
(4)	318057		Allen key	1
(5)	318017		Screw #8* 30mm	6

THE HARDWARE IS LOCATED IN THE PACKING ITEM

**MUST: TIGHTEN SCREWS PERIODICALLY. WITH USE SCREW
MAY ENCOME LOOSE CHECK TIGHTNESS OF ALL SCREWS EVERY 6-8
WEEKS.**

CLEANING INSTRUCTIONS:

After assembly, clean and polish the completed parts if necessary with soft cloth and industrial recognized furniture polish.

STEP 1

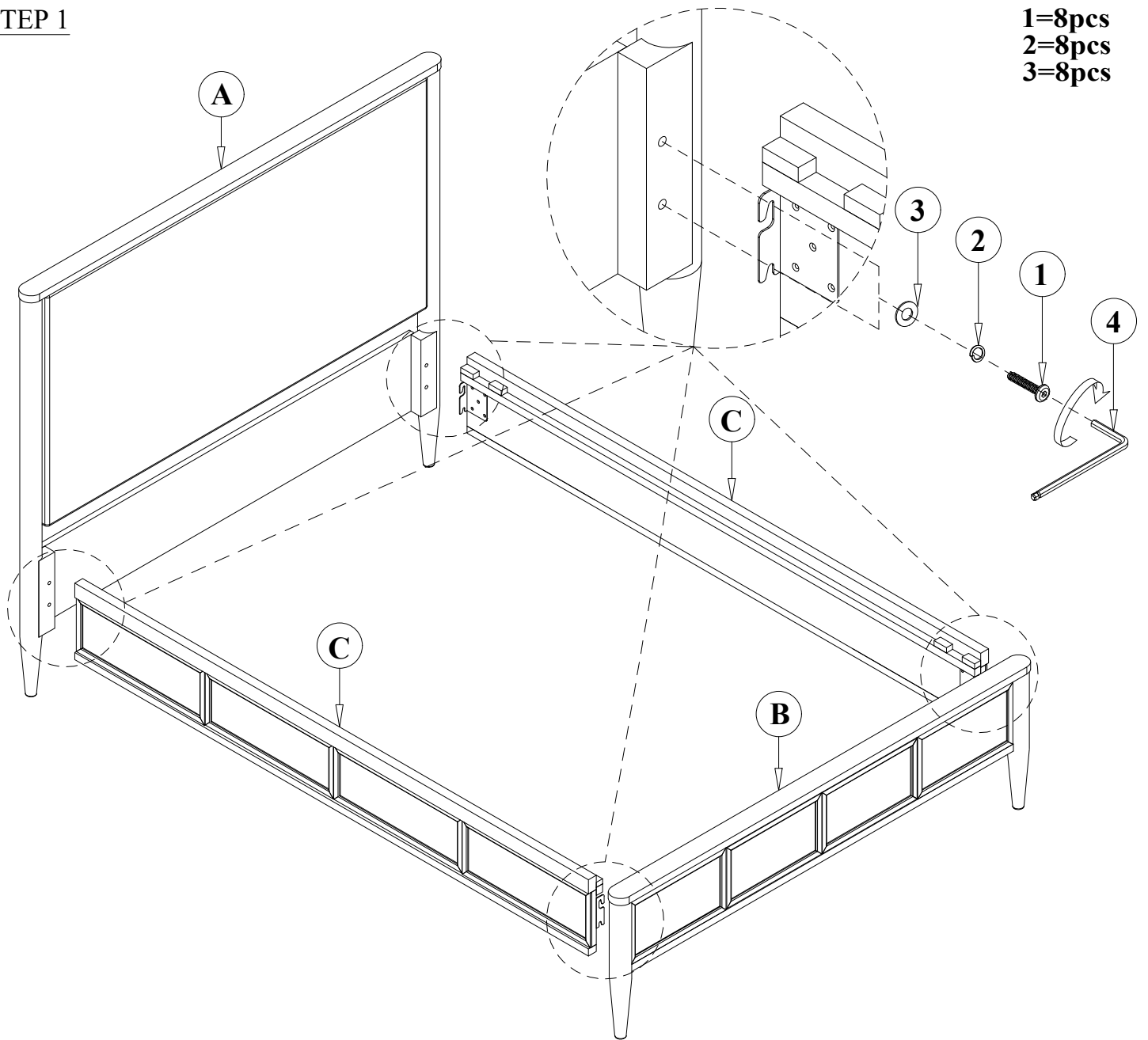

STEP 2

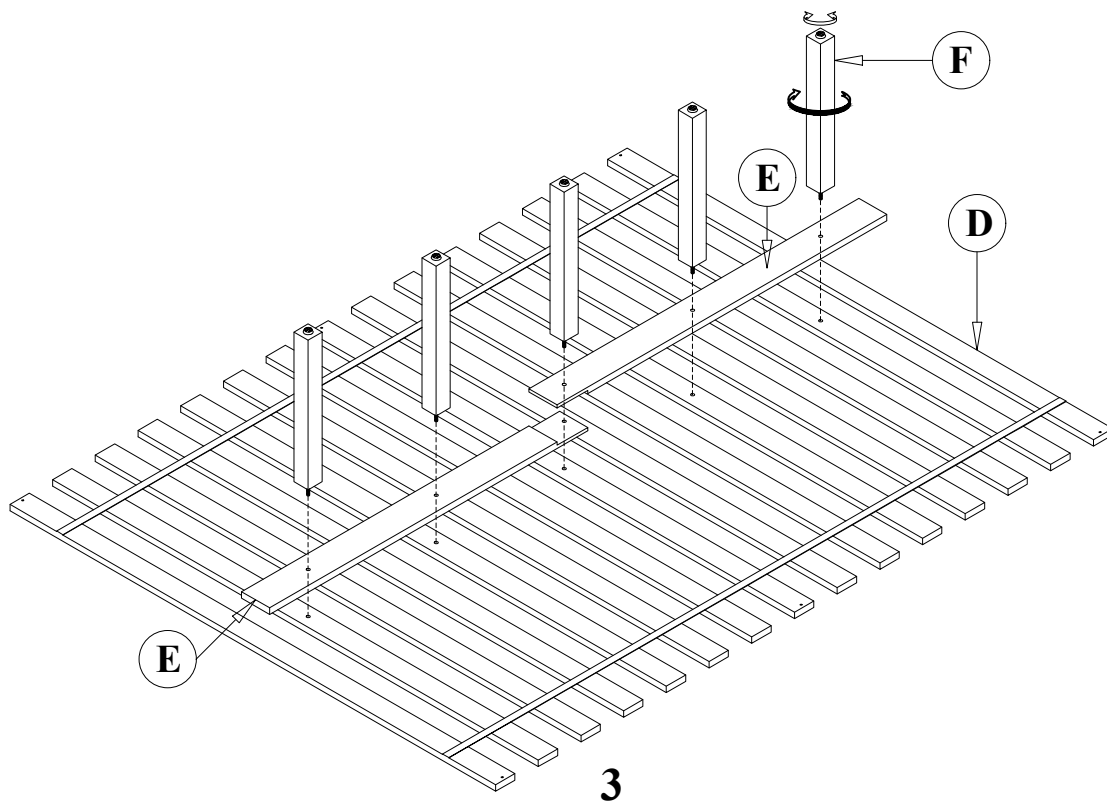

STEP 3

5=6pcs

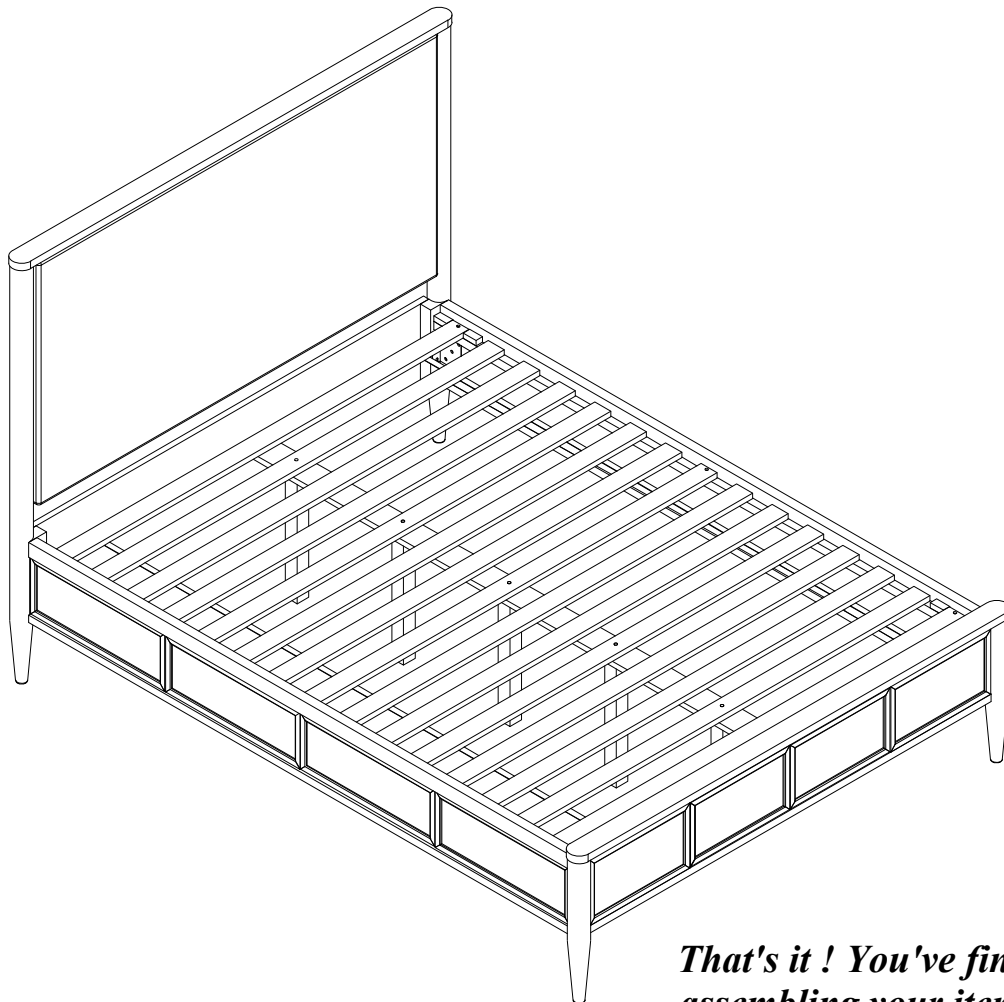
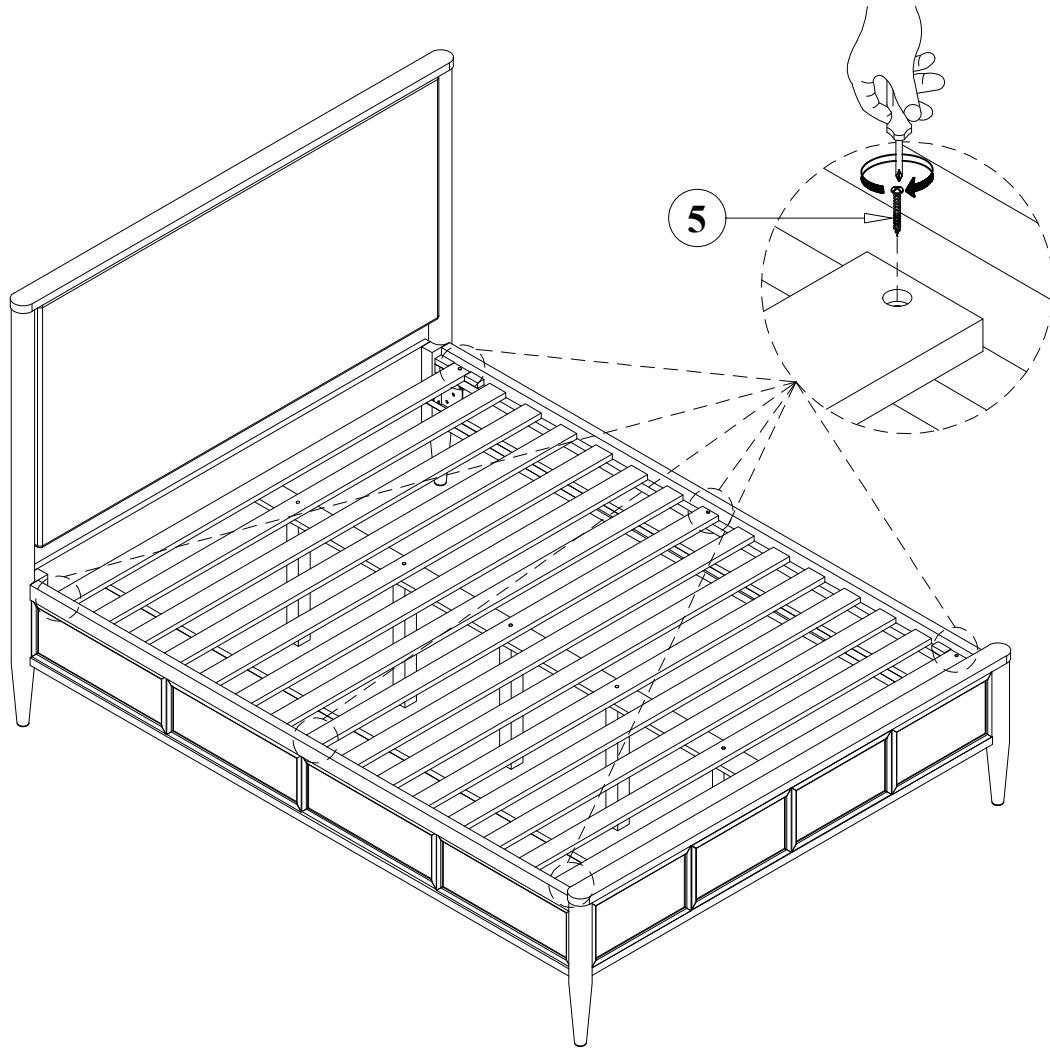

*That's it ! You've finished
assembling your item. Thank you!*

4