

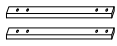

ASSEMBLY INSTRUCTION

ITEM : B9200-11 MIRROR



BOX OF MIRROR MIRROR

ITEM	DRAWING	DESCRIPTION	QTY
A		MIRROR	1
B		MIRROR SUPPORT RAIL	2

BOX OF DRESSER DRESSER

ITEM	DRAWING	DESCRIPTION	QTY
A		DRESSER	1

BOX OF MIRROR HARDWARE LIST

ITEM	DRAWING	DESCRIPTION	QTY
1		JCBC SCREW M6x40mm	8
2		L-KEY M4x65mm	1

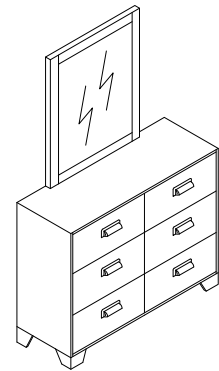

COMPLETED MIRROR ASSEMBLY

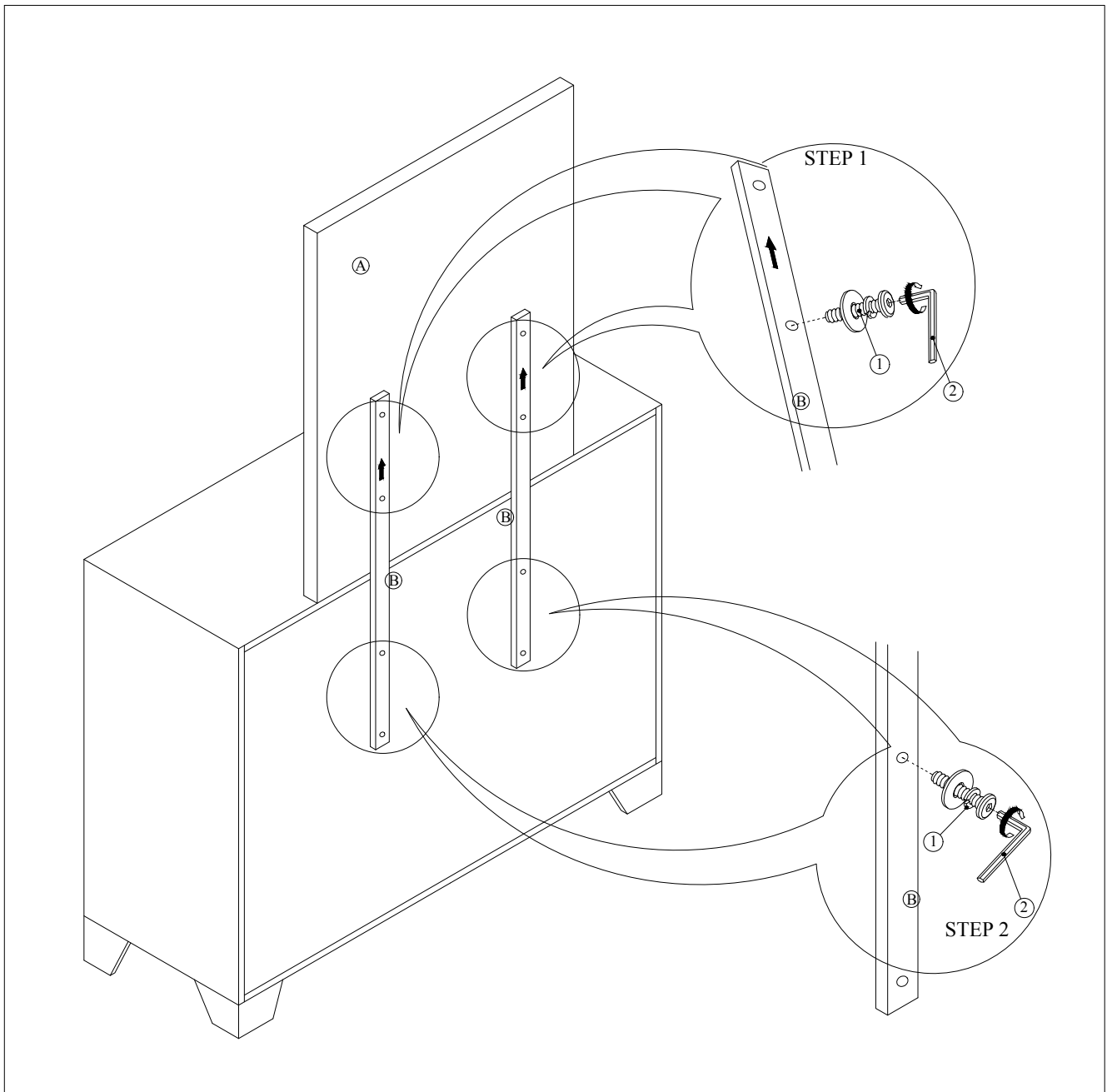

THE HARDWARE IS LOCATED IN THE PACKING ITEMS

NOTE : MUST TIGHT SCREWS PERIODICALL. WITH USE SCREWS MAY BECOME LOOSE.
CHECK TIGHNESS OF ALL SCREWS EVERY 6-8 WEEKS.

MADE IN MALAYSIA