

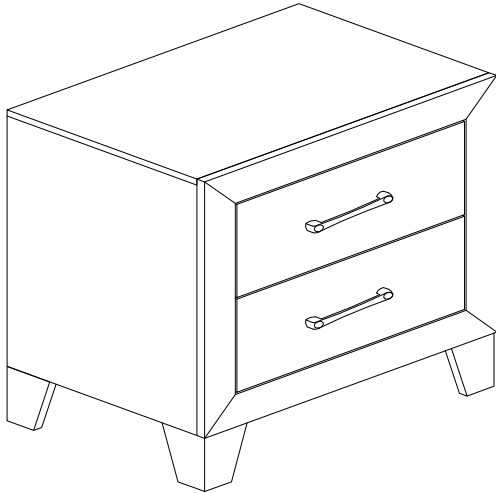

NIGHT STAND

B9310-2 Night Stand

Thank you for purchasing this quality product . Be sure to check all packing material carefully for small parts that may have come loose inside the carton during shipment.

****Do not fully tighten screws until fully assembled****



Box of Night Stand		
NO	DESCRIPTION	QTY
1	 NIGHT STAND	1
2	 CASEGOODS LEG	4

Box of Night Stand - Hardware List			
A		JCBC BOLT M6 x 1.0 x 40 mm	8
B		ALLEN KEY - M4	1
C		ANTI-DUMPING HARDWARE KIT	1

COMPLETE ASSEMBLY

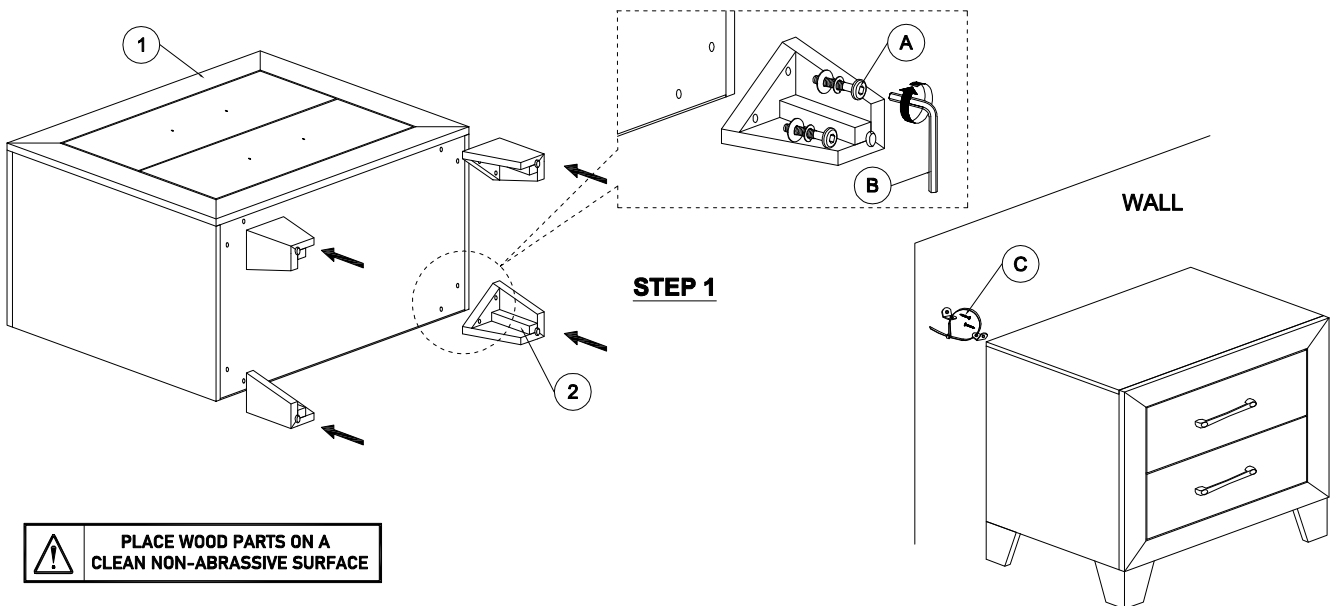

 PLACE WOOD PARTS ON A CLEAN NON-ABRASSIVE SURFACE

STEP 2
REMOVE HANDLES.

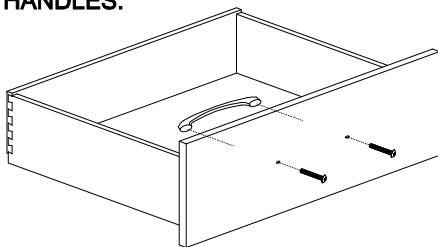

STEP 3
REFIX HANDLE ON OUTSIDE.

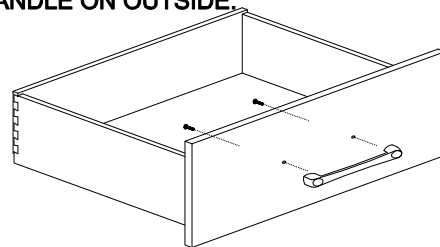

The Hardware is Located in the Packing Items.

NOTE : Pictures for illustration purpose only.

MADE IN MALAYSIA