







CAUTION: PLEASE READ ALL INSTRUCTIONS BEFORE STARTING THE ASSEMBLY OF THIS PRODUCT. THESE PIECES ARE HEAVY. IN ORDER TO PREVENT PERSONAL INJURY AND ENSURE THAT THIS PRODUCT IS NOT DAMAGED DURING THE ASSEMBLY PROCESS, IT IS STRONGLY RECOMMENDED TO ENLIST THE ASSISTANCE OF ONE OR MORE PERSONS. IN CASE OF EXCESS STAIN, WIPE THE BOTTOM OF THE UNIT BEFORE PLACING IN ANY SURFACE.

ATTENTION: VEUILLEZ LIRE TOUTES LES INSTRUCTIONS AVANT DE COMMENCER L'ASSEMBLAGE DE CE PRODUIT. LES PIÈCES SONT LOURDES. POUR ÉVITER TOUTE BLESSURE ET POUR VOUS, ASSURER QUE LE PRODUIT N'EST PAS ENDOMMAGÉ PENDANT L'ASSEMBLAGE, NOUS VOUS RECOMMANDONS DE FAIRE APPEL À UNE OU PLUSIEURS AUTRES PERSONNES. EN CAS DE TACHE EXCESSIVE, ESSUYEZ LE FOND DE L'UNITÉ AVANT LE PLACEMENT SUR N'IMPORTE QUELLE SURFACE.



CUIDADO: FAVOR DE LEER TODAS LAS INSTRUCCIONES ANTES DE ENSAMBLAR SU PRODUCTO, ESTAS. PIEZAS SON PESADAS. PARA PREVENIR HERIDAS PERSONALES Y ASEGURAR QUE SU PRODUCTO NO SEA DAÑADO MIENTRAS ES ENSAMBLADO. SE RECOMIENDA LA ASISTENCIA DE UNA O MÁS PERSONAS.

WARNING: PROTECTIVE GLIDE IS PLACED UNDER EACH LEG OF THE FURNITURE TO RESIST SCRATCHES ON FLOOR SURFACE. SOME FLOOR SURFACES CAN BE EXTRA SENSITIVE TO SCRATCHES AND MARKINGS, IF YOU ARE NOT SURE CONSULT WITH YOUR DEALER.
AVERTISSEMENT. LES PIEDS DES MEUBLES SONT MUNIS DE PATINS DESTINÉS À PROTÉGER LE PLANCHER. CERTAINS REVÊTEMENTS DE SOL PEUVENT ÊTRE TRÈS FRAGILES. EN CAS DE DOUTE. CONSULTER LE MARCHAND.

LIST OF PARTS AND HARDWARE/ LISTE DES PIÈCES ET DU MATÉRIEL/ LISTA DE PIEZAS Y HARDWARE

| NO#/ NOMBRE/ NÚMERO | DESCRIPTION/ DESCRIPTION/ DESCRIPCIÓN | QUANTITY/ QUANTITÉ/ CANTIDAD |
|---------------------------|--|--|
| 1 | Hex Nut / Écrou hexagonal/ Tuerca hexagonal Ø 5/16" x 12 mm |  12 pcs |
| 2 | Lock washer/ Rondelle de blocage/ Arandela de bloqueo Ø 5/16" x 13 mm |  12 pcs |
| 3 | Flat washer/ Rondelle plate/ Arandela plana Ø 5/16" x 19 mm |  12 pcs |
| 4 | Open Wrench/ Clé à Fourche/ Llave de Boca Ø 1/4" x 32 mm |  4 pcs |
| 5 | Allen Wrench/ Clé Allen/ Llave inglesa Allen 4 mm |  1 pc |
| 6 | Open Wrench/ Clé à Fourche/ Llave de Boca 12 mm |  1 pc |

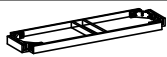
LIST OF PARTS AND HARDWARE/ LISTE DES PIÈCES ET DU MATÉRIEL/ LISTA DE PIEZAS Y HARDWARE

| NO#/ NOMBRE/ NÚMERO | DESCRIPTION/ DESCRIPTION/ DESCRIPCIÓN | QUANTITY/ QUANTITÉ/ CANTIDAD |
|---------------------------|--|---|
| A | Bench top / Dessus de Banc / Tablero de Banco |  1 pc |
| B | Bench Side Leg / Banc Côté Jambe / Pata lateral del banco |  4 pcs |
| C | Bench Center Leg / Pied central du banc / Pata central del banco |  2 pcs |

NOTE:
ASSEMBLE UNIT ON A SOFT SURFACE.
ASSEMBLEZ L'UNITÉ SUR UNE SURFACE MOLLE.
ENSAMBLE LA UNIDAD EN UNA SUPERFICIE PLANA Y SUAVE.
DO NOT TIGHTEN BOLTS UNTIL THE UNIT IS COMPLETELY ASSEMBLED.
NE SERREZ PAS LES BOULONS JUSQU'À CE QUE L'UNITÉ SOIT COMPLÈTEMENT ASSEMBLÉE. NO APRIETE LOS TORNILLOS HASTA QUE LA UNIDAD ESTE COMPLETAMENTE ENSAMBLADA.

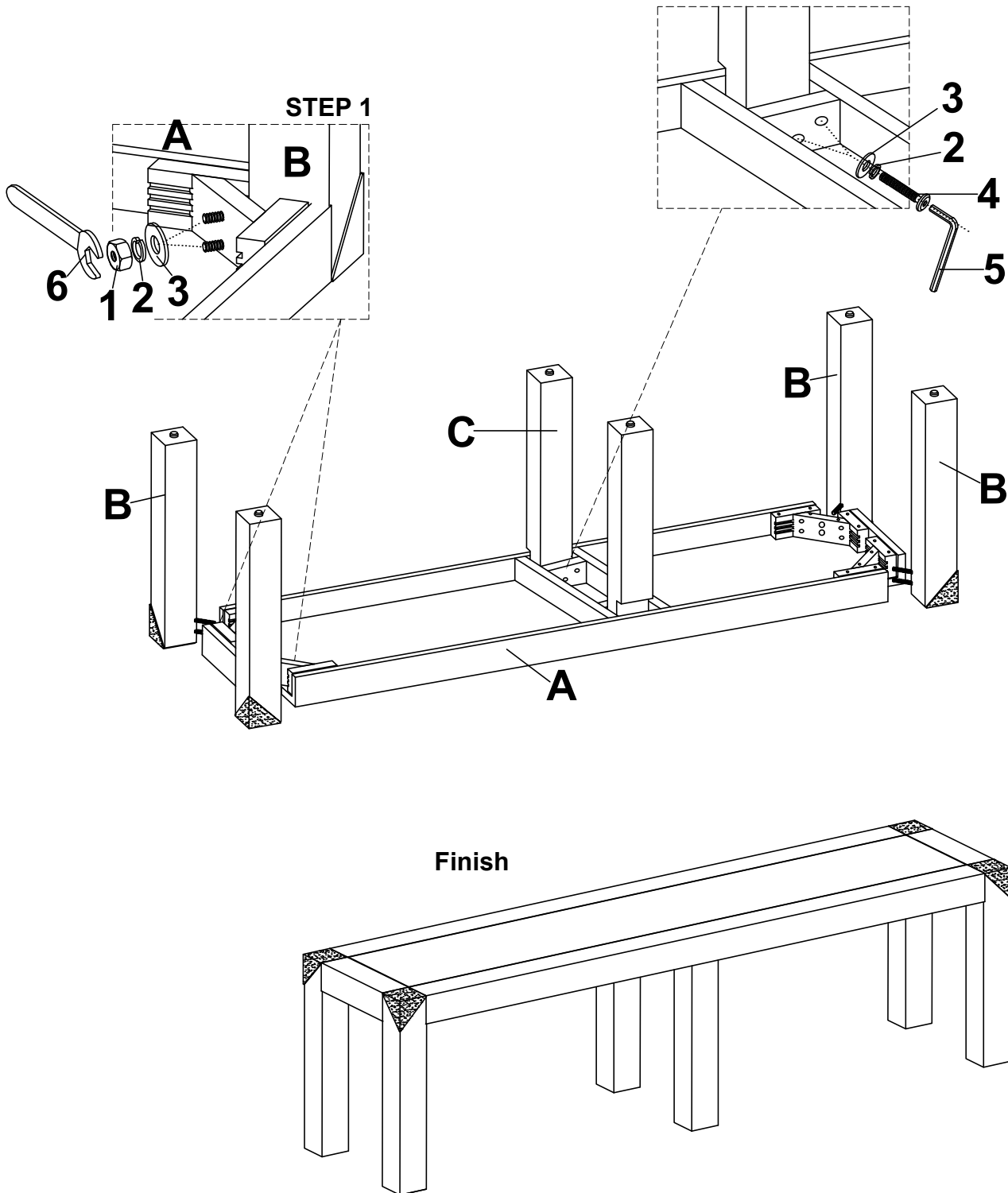

Note:

Prior to tightening all bolts,
 Place the chair upright on a
 level surface. Push gently down
 on seat to even out leg placement,
 then fully tighten bolts.