

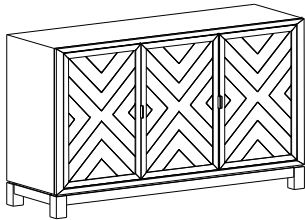

LIVING SPACES

1	PD5333-14BU		X1
2	PD5333-14SH1		X3
3	PD5333-14BU		X1
4	PD5333-08SC1		X12
5	P99-00R		X1

AINSLEY



1

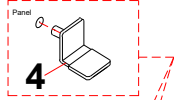

OPTION 1

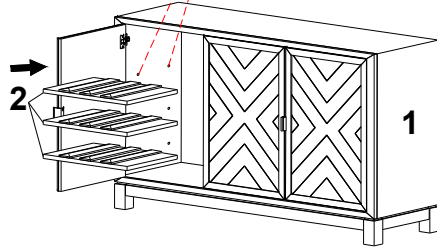

2

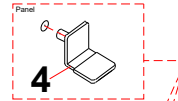

OPTION 2

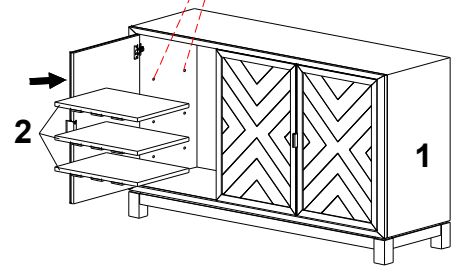

3

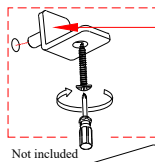

SHELF CLIP WITH SCREW

Not included

The Adjustable Shelves for the case are fixed with screws for shipping purposes. To adjust the Adjustable Shelf, remove the screws from the Shelf Pins and relocate the Shelf clip to the holes at the desired level. Install the Adjustable Shelf onto the Shelf clip.

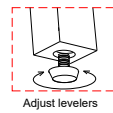
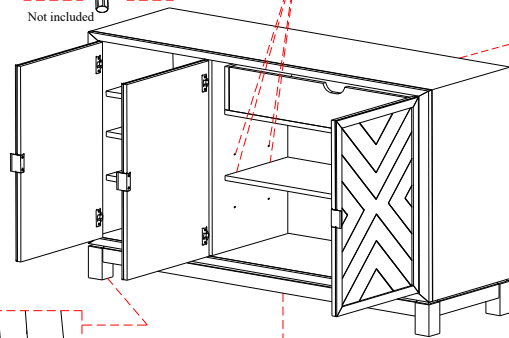
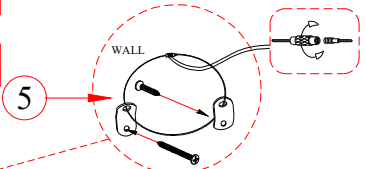

Adjust levelers

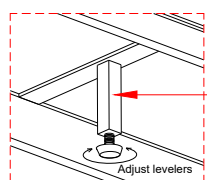

3

Adjust levelers

282670  
LS-D5333-14 BUFFET



Not provided

NOTE:  
THE TABLE OR CASE SHOULD BE LOCKED IN POSITION  
AND LEVELLED USING A SPIRIT LEVEL. (SPIRIT LEVEL NOT INCLUDED)



WARNING:  
ONLY USE THE HAND  
TOOLS PROVIDED