



ASSEMBLY INSTRUCTION

JOREN PLATFORM BED
 Queen LS SKU # 281465, 281464, 281466
 King LS SKU # 281457, 281456, 281458
 CAL King LS SKU # 281449, 281448, 281450







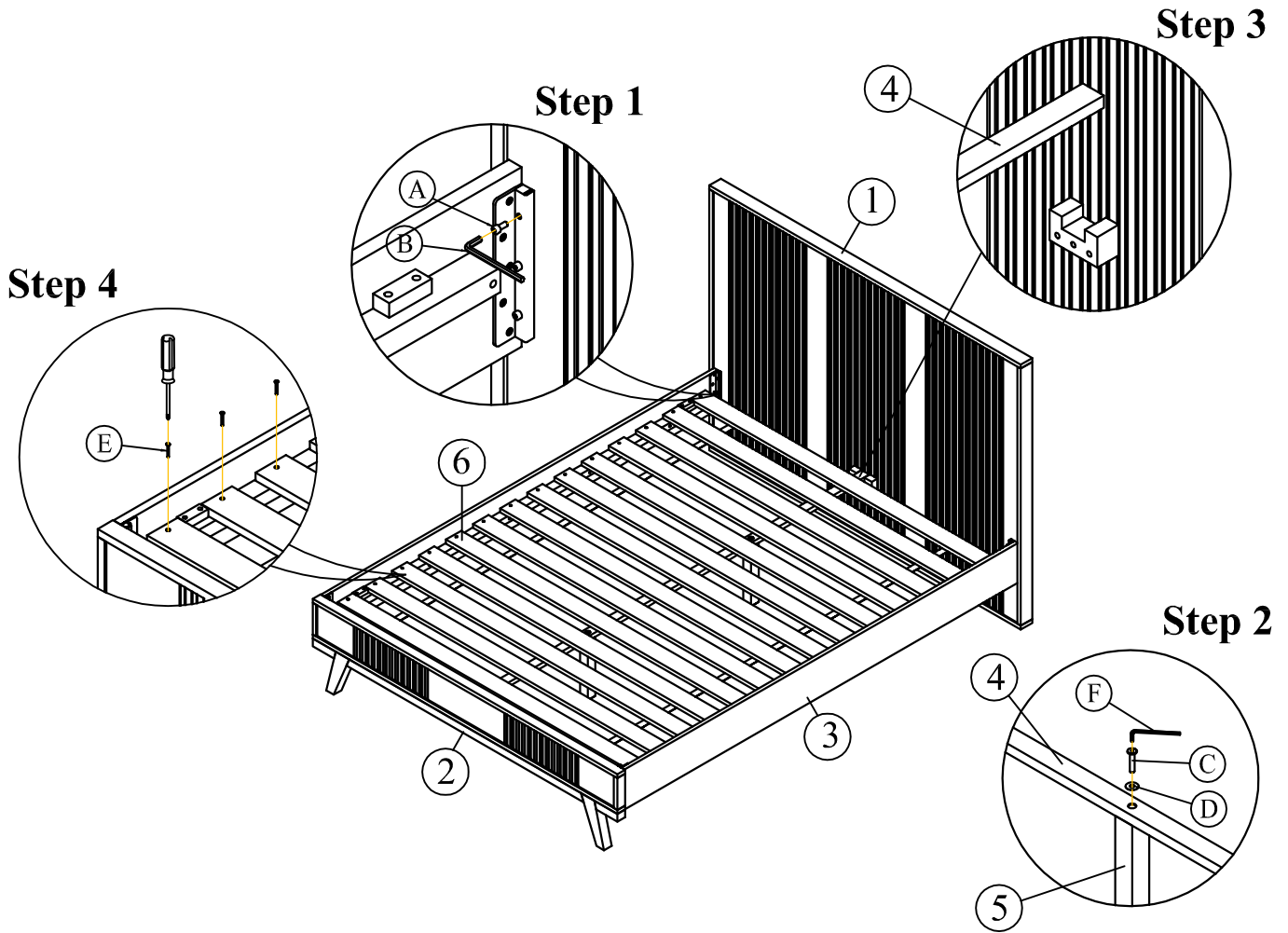

CAUTION: PLEASE READ ALL INTRUCTIONS BEFORE STARTING THE ASSEMBLY OF THIS PRODUCT. THESE PIECES ARE HEAVY. IN ORDER PREVENT PERSONAL INJURY AND ENSURE THAT THIS PRODUCT IS NOT DAMAGED DURING THE ATTENTION: ASSEMBLY PROCESS, IT IS STRONGLY RECOMMENDED THAT YOU ENLIST THE ASSISTANCE OF ONE OR MORE PEOPLE.

ATTENTION: VEUILLEZ LIRE TOUTES LES INSTRUCTIONS AVANT DE COMMENCER L'ASSEMBLAGE DE CE PRODUIT. LES PENDANT L'ASSEMBLAGE, POUR EUVITER BLESSURE ET POUR QUE LE PAS ENDOMMAGE CUIDADO OR DE LEER VOUS RECOMMANDONS DE FAIRE APPEL UN AUTRES PERSONNES.

CUIDADO: FAVOR DE LEER TODAS LAS INSTRUCCIONES ANTES DE ENSAMBLAR SU PRODUCTO. ESTAS PIEZAS SON PESADAS. PARA PREVENIR HERIDAS PERSONALES Y ASEGURAR QUE SU PRODUCTO NO SEA DAÑADO MIENTRAS ES ENSAMBLADO. SE LE RECOMIENDA LA ASISTENCIA DE UNA O MAS PERSONAS.



LIST OF PARTS AND HARDWARE			
No.	Description		Q'ty
A	 Bolt Ø6 x 10mm		12
B	 Allen Key 5mm		1
C	 Bolt Ø8 x 40mm		2
D	 Washer Ø8x18x2mm		2
E	 Screw Ø4 x 30mm		28
F	 Allen Key 4mm		1

LIST OF PARTS AND HARDWARE			
No.	Description		Q'ty
1	Headboard Panel (Box 1 of 3)		1
2	Footboard Panel (Box 2 of 3)		1
3	Side Rail (Box 3 of 3)		2
4	Middle Rail (Box 3 of 3)		1
5	Middle Support (Box 3 of 3)		2
6	Slat (Box 2 of 3)		14