

STEP 5

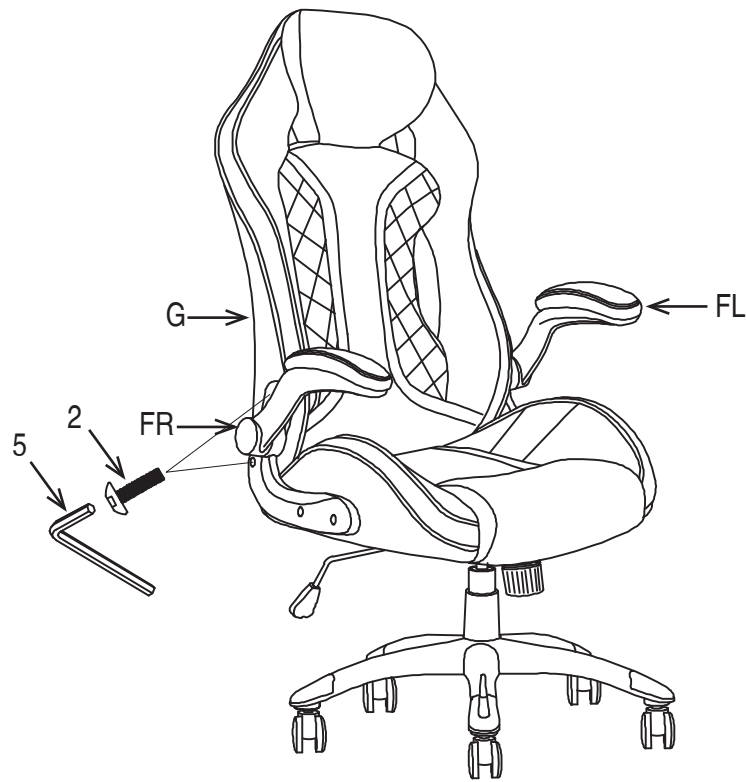

STEP 6

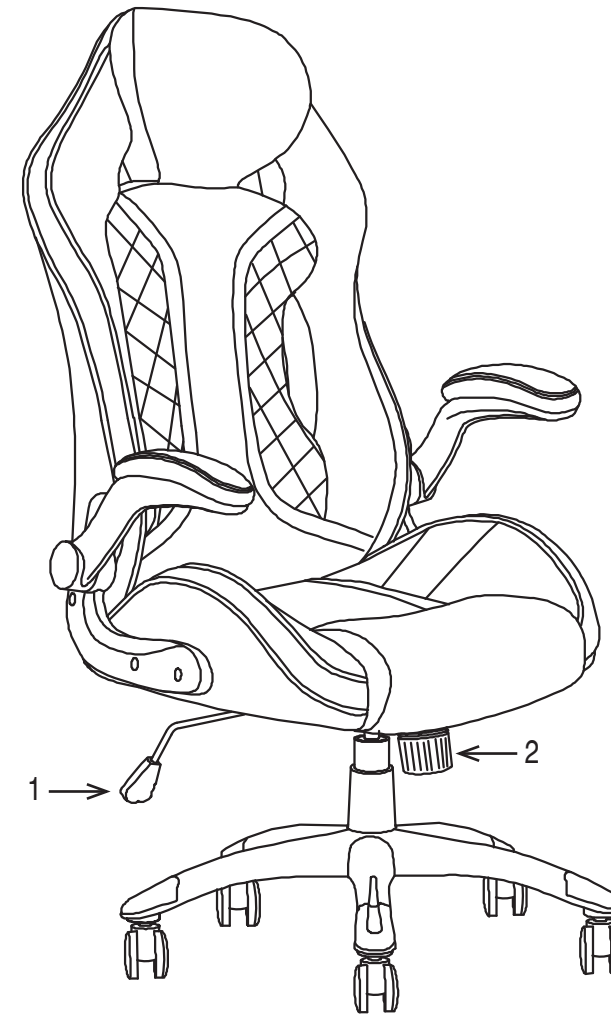
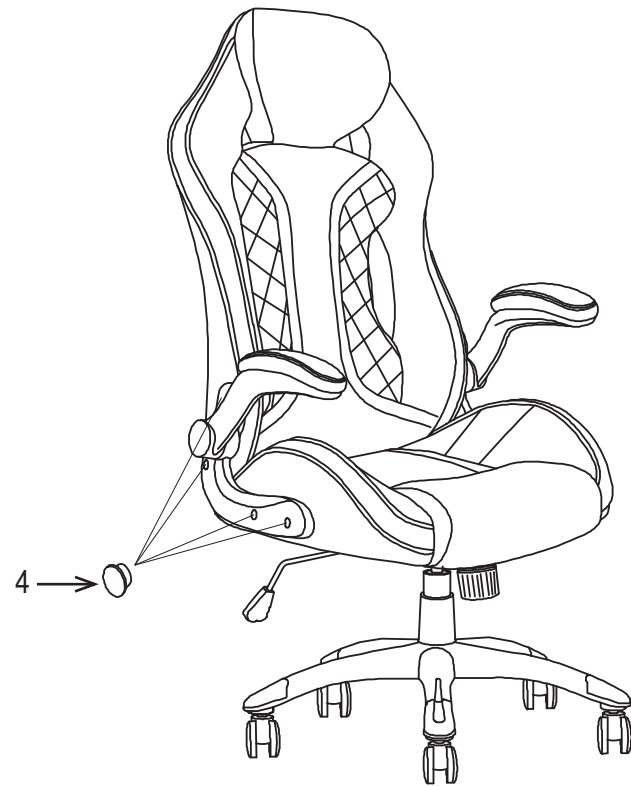

FEATURES

• **PNEUMATIC SEAT HEIGHT ADJUSTMENT**

To raise seat remove pressure from seat and pull lever (1) up.
To lower seat height sit on chair and pull lever (1) up.

NOTE: It is normal for chair to slightly lower under body weight.

• **LOCKING TILT ADJUSTMENT**

For individual comfort, this chair has been equipped with an adjustment that will allow the user to change the tension of the tilting feature. Turn knob (2) clockwise to increase tension and counter-clockwise to decrease or ease the tension. To lock return chair to the upright position and push lever (1) in. To unlock pull lever (1) out.

NOTE: Be careful not to loosen back tilt adjustment knob completely.





• **FLIP ARM**

To flip arms up, simply pull up on arm. To lower arm, simply pull down on arm.

WARNING

1. Use this product only one person at a time.
2. Do not use this chair unless all bolts screws and knobs are securely tightened.
3. Check that all bolts screws and knobs are tight every three months or as needed.
4. Do not overturn back tilt knob when decreasing tension.
5. Dispose of packing material properly. Do not use plastic cover as head covering. It may cause suffocation.
6. Do not use chair as a stepladder.
7. Use this chair for its intended purpose only.
8. Use mild detergent only for cleaning.

HARDWARE LIST

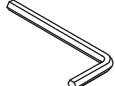
| NO | DRAWING | DESCRIPTION | SIZE | QUANTITY |
|----|---|--------------|----------|----------|
| 1 |  | Screw | 6 X 20mm | 4 PCS |
| 2 |  | Screw | 8 X 25mm | 8 PCS |
| 3 |  | Flat Washer | 6 X 18mm | 4 PCS |
| 4 |  | Plastic Cap | ∅ | 8 PCS |
| 5 |  | Allen Wrench | M6 | 1 PC |

PARTS



(A) Caster (5 PCS)

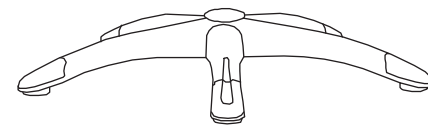

(B) Base (1 PC)

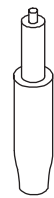

(C) Pneumatic Cylinder (1 PC)



(D) Bellows (1 PC)

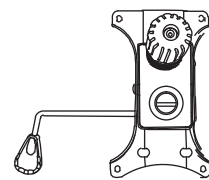

(E) Seat Plate (1 PC)

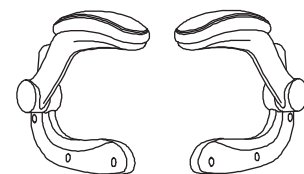

(F) Arms (L & R) (2 PCS)

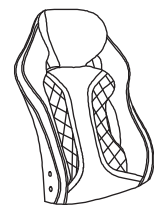

(G) Back Cushion (1 PC)

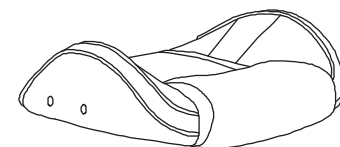

(H) Seat Cushion (1 PC)

LIVING SPACES

XPL5125
XPLOER 51 GAMING CHAIR
ASSEMBLY INSTRUCTIONS

STEP 1

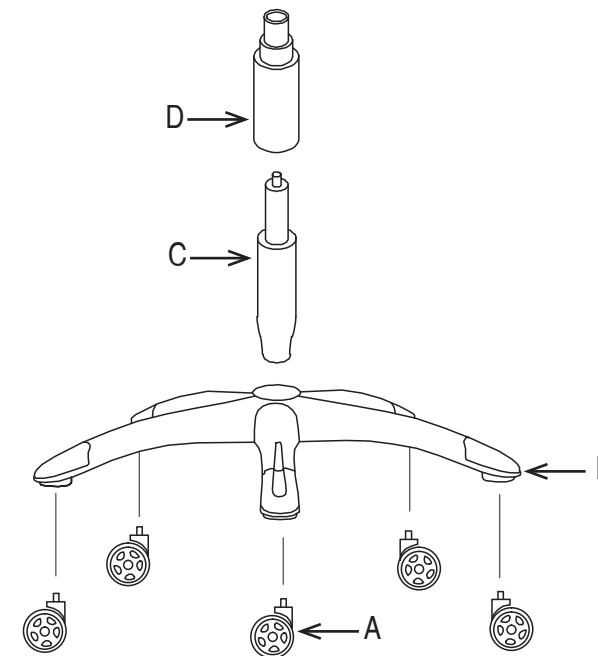

STEP 2

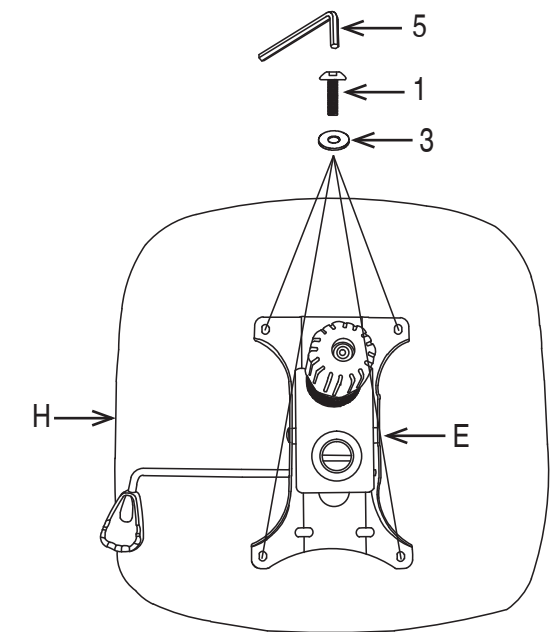

STEP 3

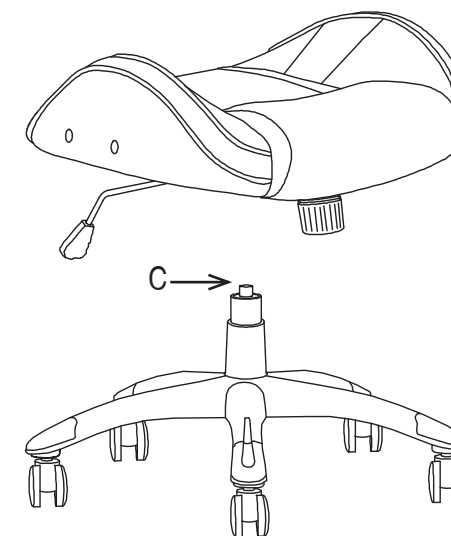

STEP 4

