



# ASSEMBLY INSTRUCTIONS

ITEM NO : B8100 / B8130 - 1 & - 11  
DRESSER & MIRROR



## BOX OF DRESSER

ITEM	DRAWING	DESCRIPTION	QTY
A		DRESSER	1

## BOX OF MIRROR

ITEM	DRAWING	DESCRIPTION	QTY
B		MIRROR	1
C		MIRROR SUPPORT	2

## (BOX OF MIRROR) HARDWARE LIST

ITEM	DRAWING	DESCRIPTION	QTY
1		FLAT HEAD SCREW (M4 x 32mm)	8
2		Assembly Tool Not Included	1

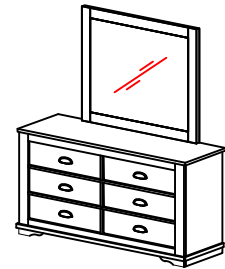

## COMPLETED DRESSER & MIRROR ASSEMBLY

### STEP 1

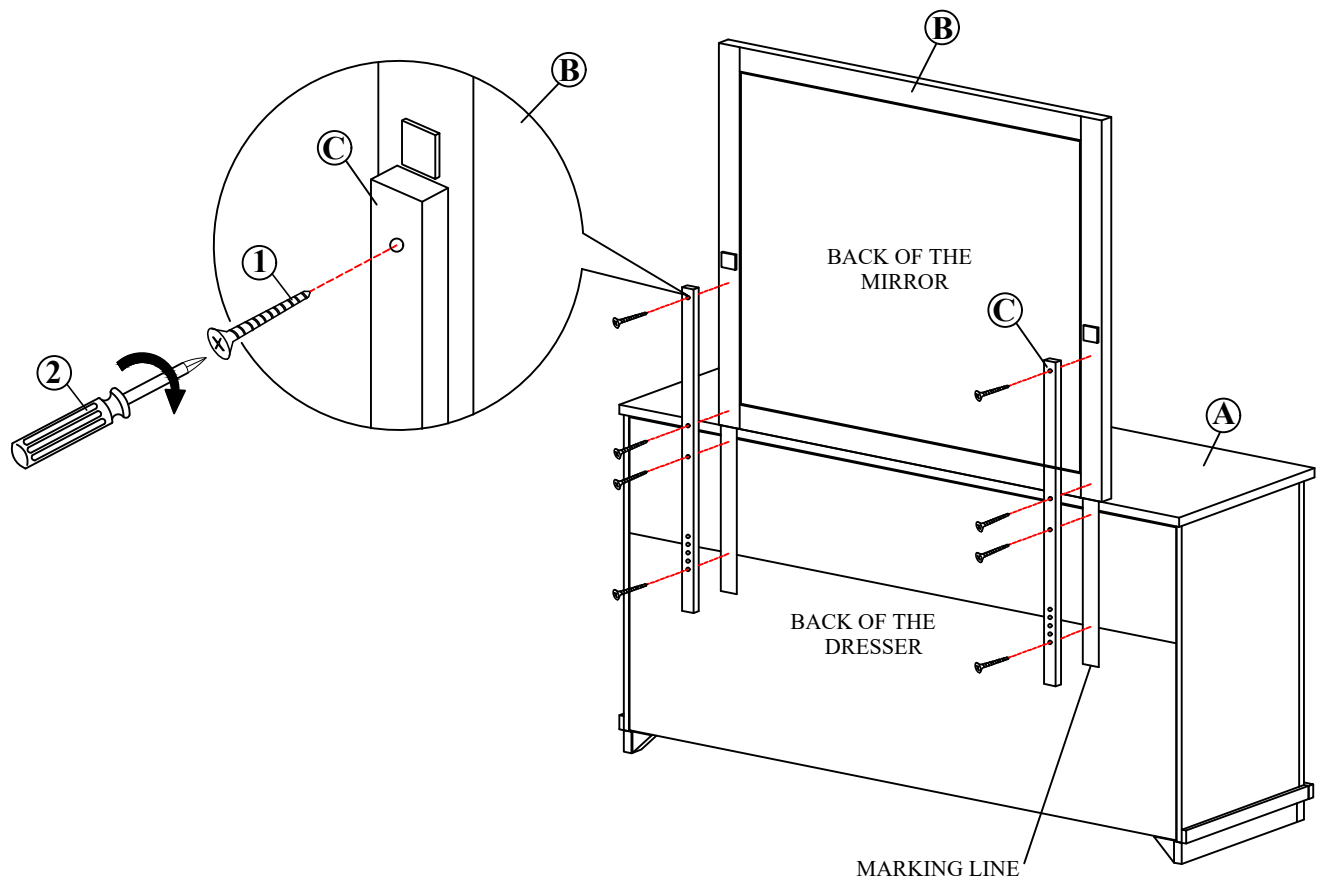

THE HARDWARE IS LOCATED IN THE PACKING ITEMS

THE ANTI TIPPING HARDWARE IS LOCATED IN THE 1ST RIGHT SIDE FRONT DRAWER OF THE DRESSER.

NOTE : MUST TIGHTEN SCREWS PERIODICALLY. WITH USE SCREW MAY BECOME LOOSE.  
CHECK TIGHTNESS OF ALL SCREW EVERY 6-8 WEEKS.

### CLEANING INSTRUCTION

After assembly, clean & polish the completed parts if necessary with soft cloth and industrial recognized furniture polish

MADE IN MALAYSIA