





## Blakely Assembly Instructions

Hardware packed behind the headboard.

A1	C	E	F	I	Y	Z
						
Φ8*40MM	Φ8*45MM	Φ8 MM	H=99 CM	Φ8 MM		
4PCS	6PCS	14PCS	2PCS	1PC	1PC	4PCS

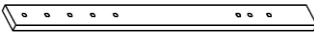

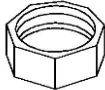
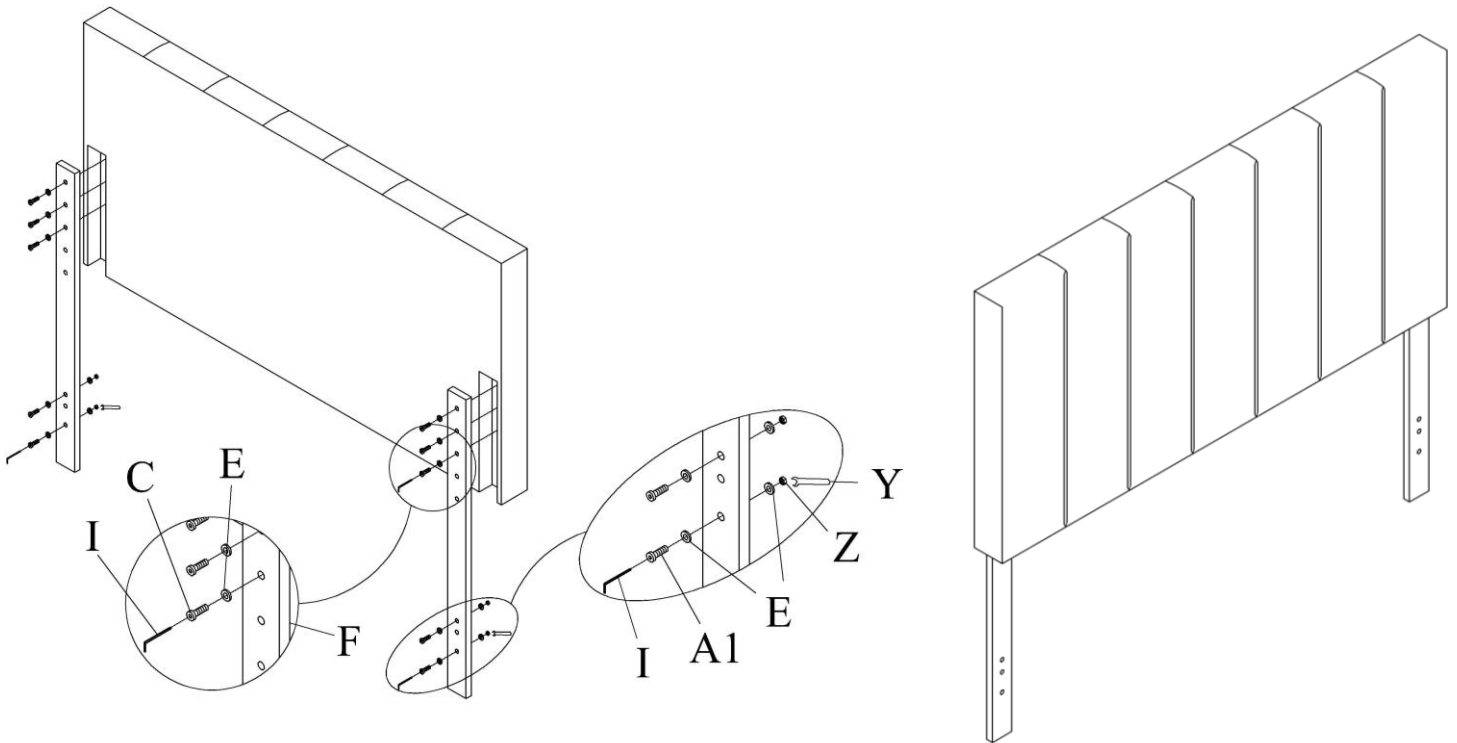
### Step#1

Retrieve bed feet and hardware from behind the headboard.

### Step#2

Attach bed feet (F) to the headboard using Wrench (I), Bolt (C) and Washer (E).

**CONGRATULATIONS ON YOUR NEW BED PURCHASE**

~Warning: do not move bed after final assembly as it may result in damages to floor and/or bed.~

**Remark:**

The installation height of the bed foot can be adjusted as required.

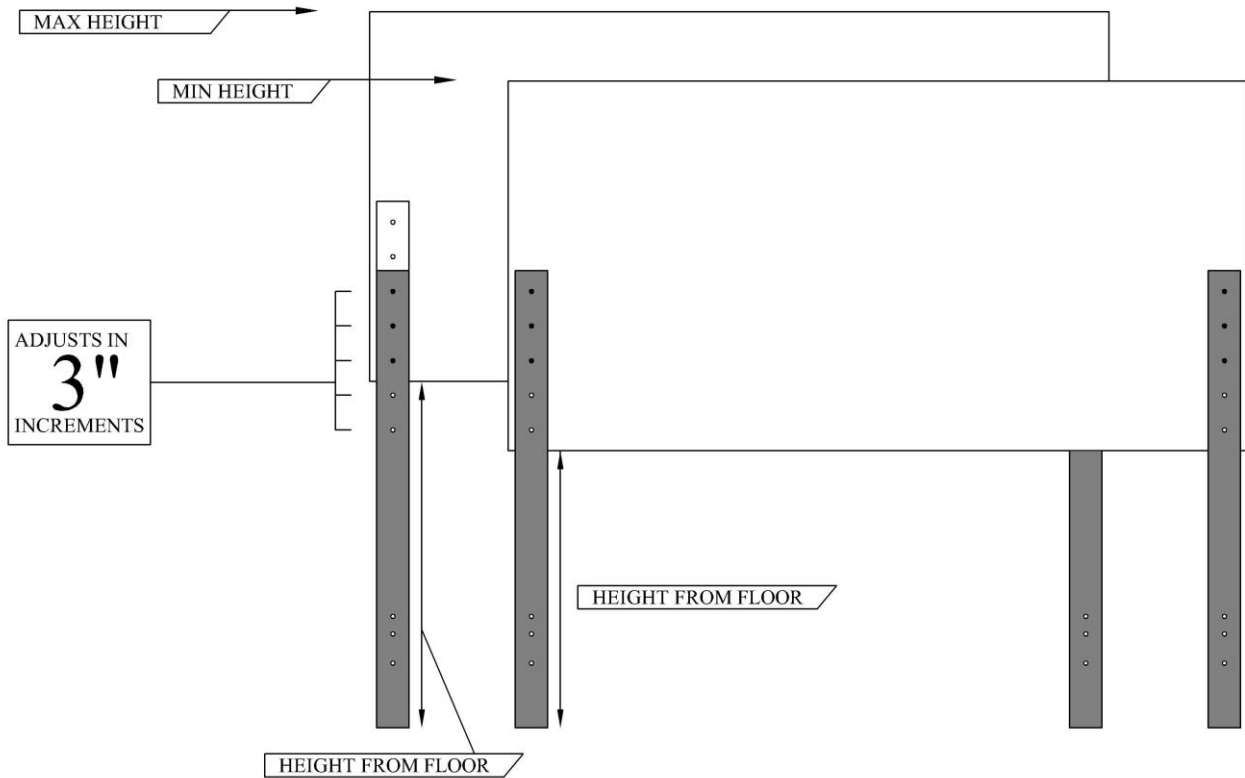

**CONGRATULATIONS ON YOUR NEW BED PURCHASE**

~Warning: do not move bed after final assembly as it may result in damages to floor and/or bed.~