

ASSEMBLY INSTRUCTION

CROWNMARK
B4630/B4620-1/B4630/B4620-11
DRESSER & MIRROR

(Box 1)

BOX OF MIRROR

NO	ITEM	Qty
A	MIRROR	1 PC
B	MIRROR SUPPORT RAIL	2 PCS

(Box 2)

BOX OF DRESSER

NO	ITEM	Qty
C	DRESSER	1 PC

(Box 1)
HARDWARE LIST

NO	ITEM	Qty
1	Csk M4 x 32mm	12 PCS

STEP 1 : Take out the mirror support (B) from the carton box.

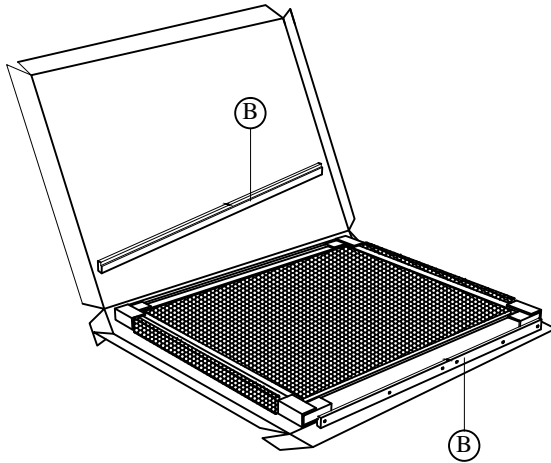

STEP 2 : Attach Mirror Support Rail (B) to Mirror (A) as shown and tighten with CSK Screw (1).

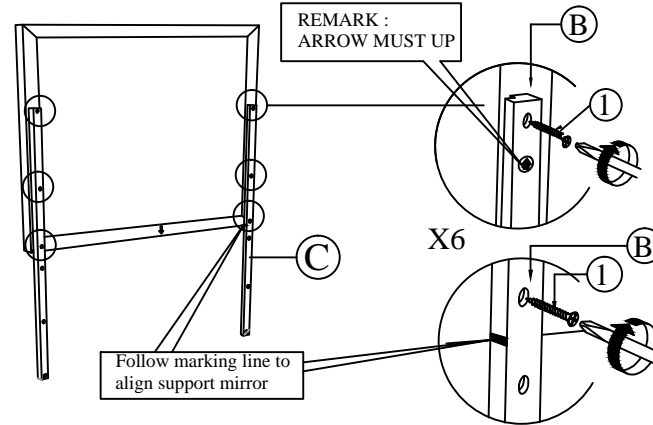

STEP 3 :
 Tighten the CSK Screw (1) as shown.

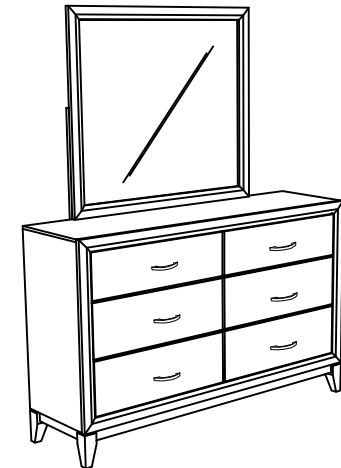
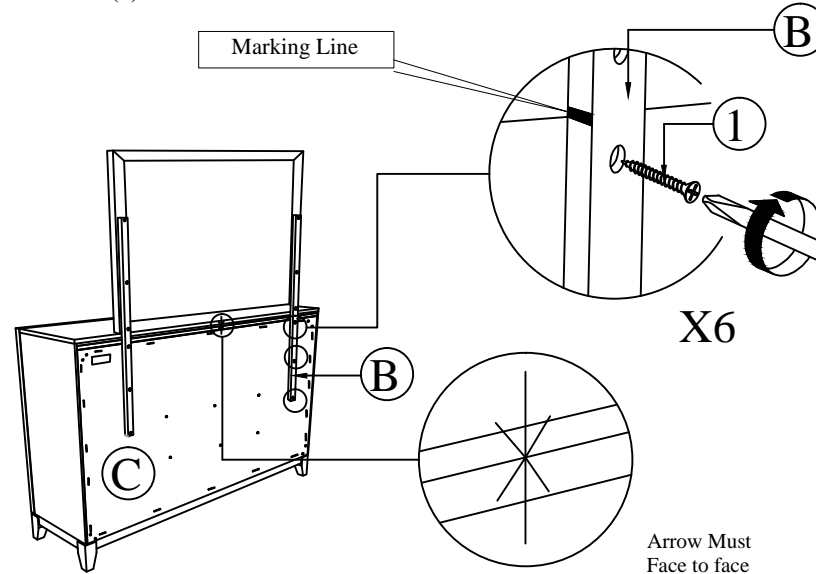

COMPLETED
ASSEMBLY

NOTE : MUST TIGHTEN SCREWS PERIODCALLY WITH USE SCREW WILL BECOME LOOSE CHECK TIGHTNESS OF ALL SCREW EVERY 6-8 WEEKS.