



LIVING SPACES



MARTINIQUE II SWIVEL BAR STOOL

16BC067A-A

217998

Assembly Instruction

Parts List:

REF	PART NAME	PART IMAGE	Q'TY
A	Seat		1
B	Base		1

Hardware List:





REF.	PART NAME	PART IMAGE	Q'TY
105	Lock Washer (M6,I D 6.5,O D 12)		4
020	Bolt (M6×25MM)		4
001	Allen Wrench (M6)		1
004	Washer (M6,I D 6.5,O D 12)		8

Diagram:

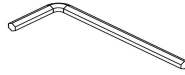

Assembly Step:

Step1:Pls remove protective wrapping and lay all parts on the floor.Make sure all parts packed in carton against attached parts list are presented.

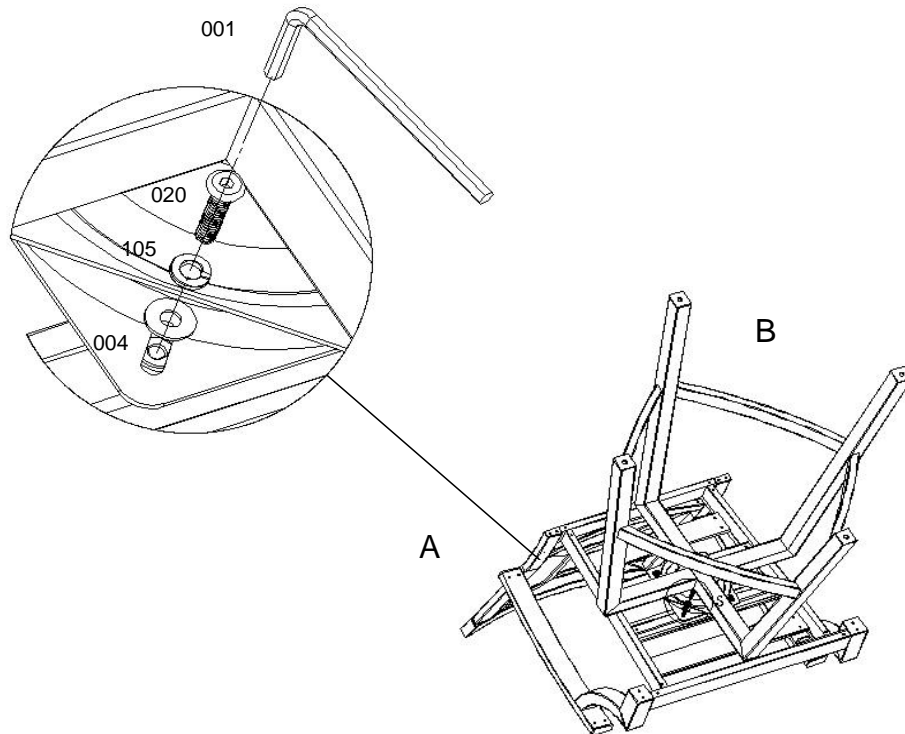
Step2:Place a protective soft material before laying the seat on floor,assemble the base as the above diagram.

Step3:After all parts are aligned and tightened properly,pls turn over the bar stool carefully with a second person's assistance.Make sure the legs are on a flat surface.