

Vendor Information	
Vendor Name:	HTL Furniture
Vendor Code:	HTLF
Parts Contact Name:	RC Parts
Phone:	626-486-2500 EXT-115
Email:	Rcparts@us.htlinternational.com

Living Spaces Information	
LS SKU:	110216 249387
LS Product Name:	TALIN
Vendor Model #:	RS-11268

CODE	PART #	DESCRIPTION	SHIPS IN 48HRS	QUANTITY	PRICING	NOTES
C	MOT-TP08-120	TRANSFORMER	YES	1		

No.	Description	Picture	Qty
A	HEADREST		1
B	SEAT		1
C	TRANSFORMER		1

TALIN



110216/249387/1S1U
POWER RECLINER

①

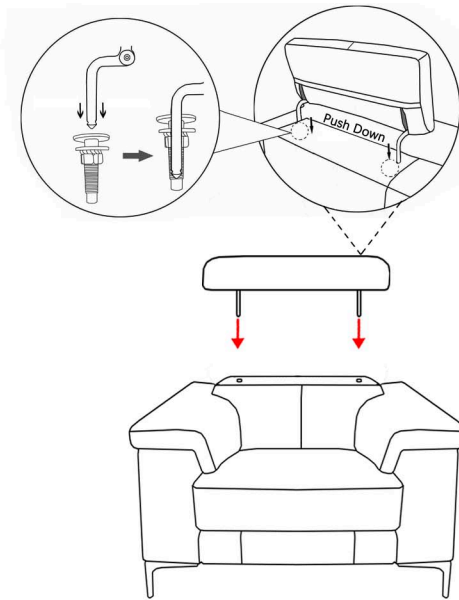

②

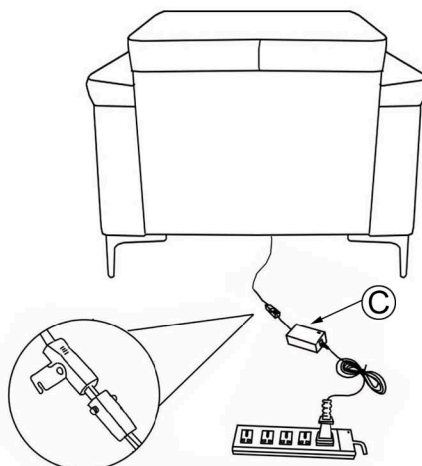



LIVING SPACES

Vendor Information

Vendor Name: HTL Furniture
 Vendor Code: HTLF
 Parts Contact Name: RC Parts
 Phone: 626-486-2500 EXT-115
 Email: Rcparts@us.htlinternational.com

Living Spaces Information

LS SKU: 110216 249387
 LS Product Name: TALIN
 Vendor Model #: RS-11268



LIVING SPACES

3

Reset the ratchet headrest by pushing all the way forward and then pushing back to the down position.

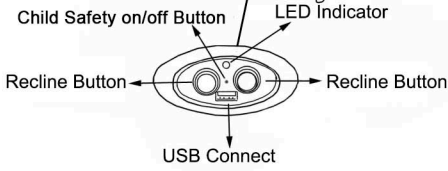
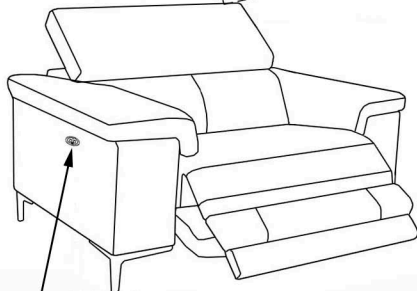
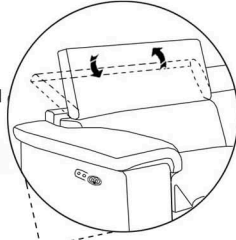

TALIN

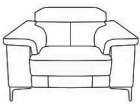

4

110216/249387/1S1U
 POWER RECLINER

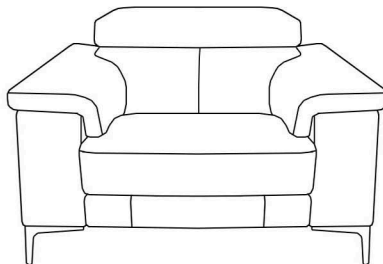

Not provided